



Randy Aton succumbs to leukemia

BY KATHY KUENZER

A long and difficult struggle with a disease that has no cure ended last week for a Plymouth boy.

Randy Aton, 9, son of Mr. and Mrs. Larry Aton of 700 Karmada St., Plymouth, died Tuesday, Dec. 2 at his home. Randy had been stricken with leukemia since last spring.

The hearts of Plymouth and Canton residents went out to Randy and his family in the last few weeks of his life. The Aton's expenses while Randy was in the hospital came as a crushing blow. But through the efforts of many who read of their plight, money and gifts began to flow to the Aton house, and especially to Randy.

Randy's grandmother, Mrs. Edith Aton, said he died quietly last Tuesday evening. "He was not afraid," she

said, "and he told his mother not to be afraid. He also said during his last weeks at home that he had everything he wanted. We just can't thank everyone enough for all they did."

Services for Randy were held last Saturday at Stockbridge, Mich., with The Rev. O.L. Holloway of the Van Born Church of God officiating. Interment was in Oaklawn Cemetery, Stockbridge.

He is survived by his parents, Larry and Shirley Aton, a brother, Kenny; paternal grandparents, Mr. and Mrs. John Aton of Plymouth; maternal grandparents, Mr. and Mrs. Roscoe Cole of Munith, Mich.; great-grandmother, Mrs. Lula Aton of Plymouth; maternal great-grandparents, also of Munith; and several aunts and uncles.

Randy was a member of Cub Scout Pack 293 of Bird School.



The Community Crier

15 cents

Vol. 2 No. 45

The Newspaper with its Heart in the Plymouth-Canton Community

December 10, 1975

Lot annexation to proceed

BY HANK MEIJER

Plymouth Township and City of Plymouth officials are expected to receive notification within the next two weeks of the state Boundary Commission's decision on annexation to the city of the 40-acre Burroughs parking lot at Plymouth Rd. and Haggerty.

The commission gave tentative approval of the annexation at its Sept. 3 adjudicative hearing.

Since then, however, the state Court of Appeals has ruled unconstitutional a 1970 law which gave the boundary commission authority in boundary disputes.

The ruling brought the commission's decision-making to a halt. Final notice of the Burroughs annexation was held in abeyance.

Now, however, according to Jim Hyde, executive director of the boundary panel, the commission will appeal the appeals

court ruling to the state Supreme Court.

Hyde said the date of transfer of the parking lot property — a parcel both city and township officials look on as suitable for commercial development — would be the 61st day after the formal decision is made. He said an official announcement will follow a conference call between the commissioners in the next two weeks.

Transfer would take place then only if the township declined an appeal of the commission decision, Hyde said, and township officials have already indicated they will fight the decision. Burroughs Corp. notified the township recently that it would support the appeal and share legal expenses.

The city's petition to annex the Burroughs lot was one of three filed with the boundary commission by the city commission in 1974. Two other petitions sought annexation of the Hillside Inn property on Plymouth Rd. and then the remainder of the township.



Merry Christmas... park FREE in city

Free parking in downtown Plymouth appears to be the Plymouth City Commission's gift to local Christmas shoppers.

The commission is expected to waive parking fees from Monday Dec. 15 through Wednesday, Dec. 24 when it meets Monday night. The action would affect meters and lots.

Cont. on Page 16

Goodfellows sell to help kids

PLYMOUTH GOODFELLOWS were out in force Saturday on local streetcorners, selling their traditional Goodfellows editions to help ensure that there will be "No Kiddie without a Christmas" in 1975. City Commissioner Bev McAninch found a willing buyer in Ed Page, pupil personnel director for the Plymouth Schools. The Goodfellows earned \$2,027 this year. Canton Goodfellows will take to the intersection Saturday to peddle their papers, (Crier photo by Robert Cameron)

A Canton post office? Once there were two

BY KATHY KUENZER

Amid the confusion of ZIP codes, postal contract stations and new names for Canton Township, it might be well to consider a simpler time in the township when at least two post offices served Canton residents.

And who would know better about two of those post offices than a man who was son of one of the postmasters and a nephew of the other?

Earl West, now a Plymouth Township resident, says his fa-

ther, William West, ran a small general store in the Cherry Hill community in Canton, and was Cherry Hill postmaster from about 1906 until about 1917 or 1918.

"I remember he moved into the big general store just after the post office was closed because RFD came into effect," says West. "It was about the time of the great influenza epidemic — we couldn't keep onions stocked in the store

Cont. on Page 13

Crier carrier attacked

A knife wielding man wearing a ski mask attacked an 11-year old carrier for The Community Crier last Wednesday afternoon as the youngster was delivering papers in a corridor of the Deer Creek Park apartments, on Joy Rd. in Canton Township.

Scott Stevens told Wayne County Sheriff's deputies a man in a red ski mask with white stripes, a blue winter coat and green pants threatened him with what appeared to be a kitchen knife, slashing his jacket and shirt.

Scott escaped without injury.



Back when Canton had its own post office

A CANTON POST OFFICE once served township customers at the southeast corner of Sheldon Rd. and Michigan Ave. A picture taken sometime between 1900 and 1910 shows

the postmaster, William Winsor (in white shirt), with some of the local gentry. Winsor was the uncle of Earl West, a Plymouth Township resident.

Dele's
SHOES

OPEN DAILY 9 to 9
Sundays Noon to 5

Gift Special

Our
Entire
Selection
of
Daniel Green
Comfys
Specially
Priced
for
Christmas



Daniel Green
LEISURE FOOTWEAR

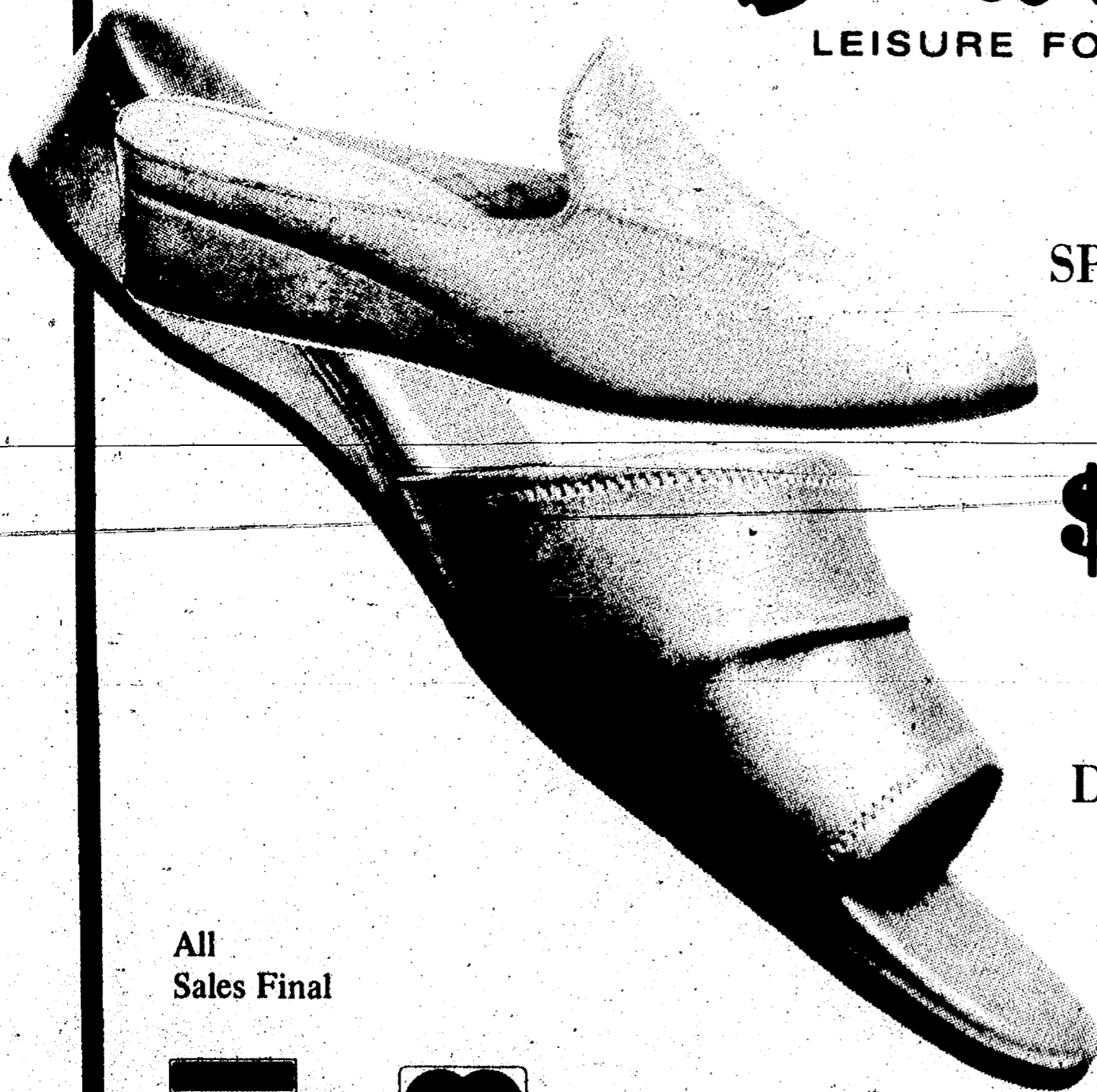

SPUNKY...

*Sueded Leather with
Warm Pile Lining*
Reg. \$11

\$7.80

DORMY...

The Ultimate Leather Scuff

\$6.80

All
Sales Final

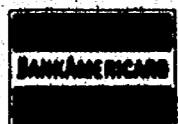

Northville, 153 E. Main Brighton, Brighton Mall
Plymouth, 322 S. Main South Lyon, 131 E. Lake
Also in Elkhart, Scottsdale, South Bend & Indianapolis, Indiana

Savings on All
Daniel Green Slippers

Local needs surveyed

Volunteers in the Community Intervention Project (CIP) of Growth Works, Inc. this week began a survey of residential areas in the Plymouth-Canton community to identify how well community services are meeting the needs of area citizens.

Volunteers will circulate survey forms in seven areas of Plymouth, Plymouth Township and Canton Township between Dec. 8 and 19 to determine personal needs and deficiencies at both neighborhood and community levels.

Results of a similar survey of young people, scheduled for January, will be compiled with this month's survey. Both survey results will be made available to the public and to community groups and service organizations to aid them in directing their own efforts at meeting community needs.

CIP intends to use the survey results to determine community deficiencies in areas relating to education, health, employment and law enforcement, with input from community members. A forecast of options for the community's future and a final strategic plan will also be studied.

Financing CIP is a \$59,000 grant from the U.S. Catholic Conference's Campaign for Human Development. The money will go toward training the economically disadvantaged and young people to carry on the CIP surveys and establish projects and alternative services to fill needs determined by the surveys.

Mail forces subscription price up

Due to rate increases announced by the U.S. Post Office, the mail subscription rate of The Community Crier is being raised immediately.

Last week the post office informed The Crier that its mailing rate was being raised 26 per cent and its permit fees 33 per cent.

To cover these increased costs, The Community Crier is immediately raising its yearly, mail subscription rate from \$8.50 to \$10 -- an increase of 18 per cent.

The cost increase applies only to new mail subscriptions. Those already in effect are unchanged. Carrier-delivered subscription prices remain the same.

"We regret that we've got to take this measure, which is certainly an inconvenience to our mail subscribers, but we can't control what the post office charges," said W. Edward Wendover, general manager of The Crier.

"Maybe with this increase, the post office will get The Crier delivered in less than three weeks -- as we've heard it takes for from some out-of-state subscribers to get their paper," Wendover added. "We're simply at the mercy of the postal system to get our paper to subscribers not served by our carriers."



'Away in the manger'

STUDENTS IN Doris Balconi's third grade class at Fiegel School acted out their own version of the nativity Monday at the Plymouth School Farm. Live animals and elaborate costumes added to the scene's authenticity. (Crier photo by Robert Cameron.)

Board asked to respond to parent survey

Schools seek modular study

BY HANK MEIJER

Plymouth School Board members Monday night told opponents of the controversial modular scheduling system at Centennial Educational Park they would make no major changes in high school scheduling until a team of university educators completed a study of scheduling and related high school programs next spring.

The board earlier rejected a resolution that would have contracted Wayne State University to do the study at a cost of about \$5,900.

Instead, administrators were directed to contact education departments at the University of Michigan and Michigan State University to ask them if they were interested in bidding on the research project.

The board unanimously agreed to seek a study that would,

as Board Vice-President Marcia Borowski put it, "Concern itself with, but not limit itself to, a cost analysis and look at staffing."

Educators will also be asked to evaluate the effectiveness of the operation of the schools in light of the goals of the more flexible modular scheduling program and evaluate the effectiveness of the program based upon the perception of teachers and students.

Police talks go on

Negotiations between the City of Plymouth and its rank and file police officers are continuing, although the police have been working without a contract since June 30.

This is the first year of negotiations between the newly formed police union bargaining as a Teamsters affiliate.

"My concern is that we have support services for the educational delivery system we call modular scheduling," said Board Member Gary Mirto. "The question is not with modular scheduling. If people think you can put traditional scheduling back in and eliminate discipline problems and attendance problems, your're wrong."

"Faulty systems are not wrong," he added, "but can be improved. Let's look at the area coordinator program. Let's look at the guidance counseling program. Those two areas have been my ongoing concerns."

Several members of the Concerned Parents organization attended the meeting, although they did not address the board until after the meeting was adjourned, at which time spokesman George Merchant told the

Cont. on Page 26

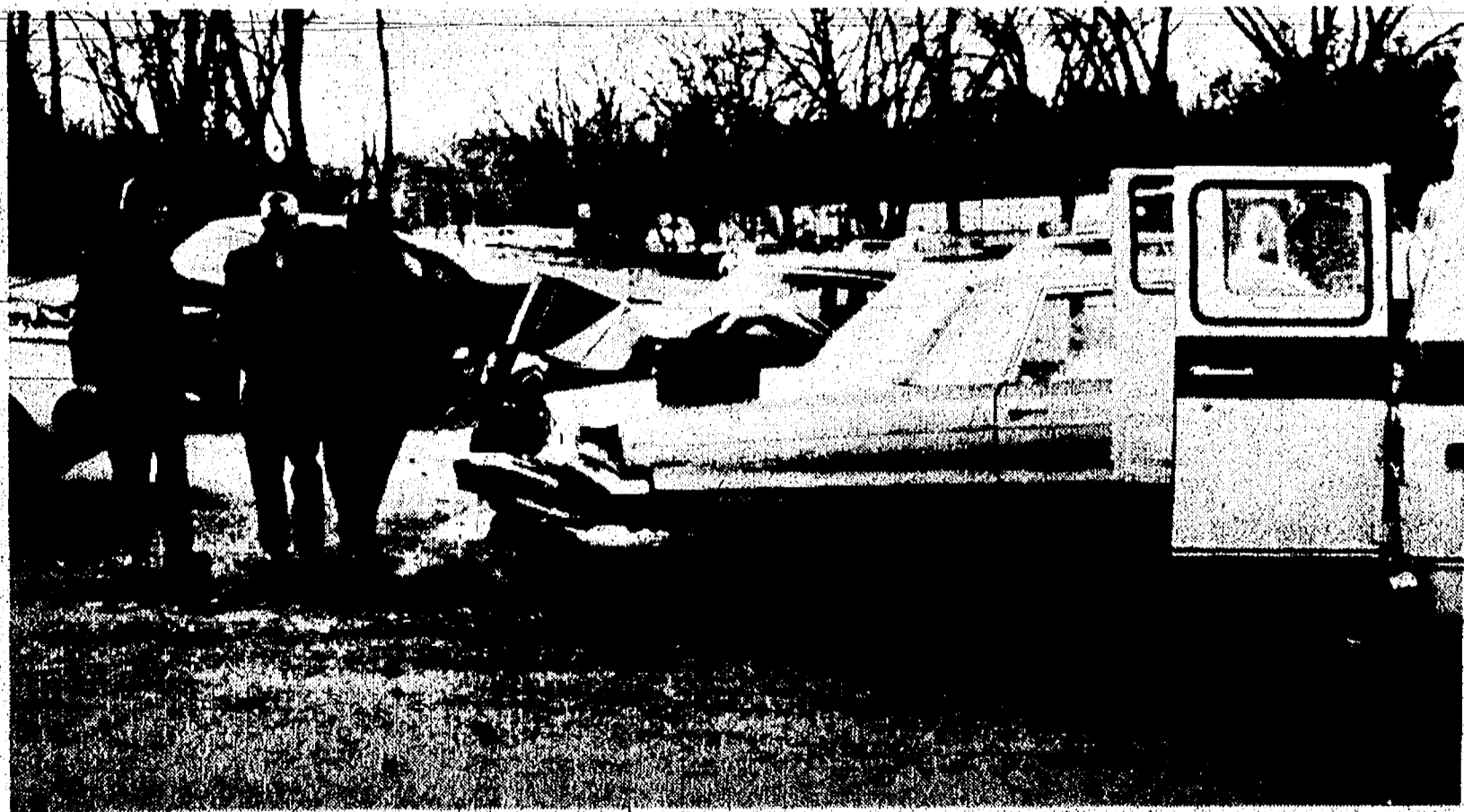

AN 83-YEAR OLD Detroit man and his 78-year old wife were reported in fair condition Tuesday in St. Mary Hospital after their car collided with another in a three-car collision at the intersection of Hines Dr. and Haggerty. Wayne County Sheriff's deputies said Charles Murray (shown being helped to a Plymouth Township rescue van) failed to yield

while driving south on Haggerty. The Murray car entered the intersection and was struck by a car driven by a 25-year old Northville man. His wife and one-year old son were treated at St. Mary's and released. That car in turn struck a third, but the driver of the third car was not injured. (Crier photo by Hank Meijer.)

DEAR SANTA

MI DADY HAS BIN A
GOOD DADY
PLES BRING HIM
SOPTHING FROM
JOHN SMITH
FOR CHRISTMAS
I LOVE
YOU JENNY

John Smith
OF PLYMOUTH

326 S. MAIN Daily 9:30 - 9:55pm '75

Canton, chamber eye joint panel

Formation of a joint committee between Canton Township and the Canton Chamber of Commerce came a step closer to reality this week as a result of a letter from Supervisor Bob Greenstein to the chamber board of directors. "We hope that the Chamber will see fit to establish a liaison committee directly with the administration or with the board (of trustees) for the purpose of promoting Canton Township

both commercially and otherwise," the letter said. "It is our firm intention to continue work with the Canton Chamber of Commerce in order to promote the betterment of our Township." The committee idea evolved from a recent series of chamber-sponsored breakfasts at which Canton businessmen gave their views of Canton and reasons for settling in the town-

ship and Canton officials discussed their plans for Canton now and in the future. A suggestion was made at the final breakfast meeting that Canton officials and chambers join forces to study the promotion of the township. Chamber President Bart Berg said the Chamber's Community Development Committee will meet soon to discuss membership on the committee.



THE MAYFLOWER POST of the Veterans of Foreign Wars and the VFW Auxiliary raised the flag Sunday and laid a wreath at Plymouth Rock in memory of American servicemen who died in the Japanese surprise attack on Pearl Harbor Dec. 7, 1941. (Crier photo by Hank Meijer)

Board buys monitors to save Salem heat

Boilers at Salem High School will soon be monitored automatically to ensure efficient use of energy in heating the school district's largest building.

The Plymouth School District Board of Education Monday night approved a lease agreement and installation of a Honeywell BOSS (Building Operation Services Systems) monitoring system, which its manufacturer claims will pay for itself in its first year of operation.

BOSS -- to be installed in Salem at a cost of about \$25,000 spread over two years, with annual expenses for the last three years of the five-year contract of about \$8,500 -- should cut district utility costs at the high school by some 13 per cent.

The system of monitors is operated by computer remotely from a Honeywell facility. Sensor alarms and temperature readings keep a 24-hour observer constantly informed of the status of heating systems in the building.

The district's energy conservation committee recommended the system, which school officials hope will be successful enough to install in its three new elementary buildings, Canton High School, and eventually in other district buildings.

Salem accounts for some 20 per cent of all energy used in the Plymouth Community Schools -- energy which last year cost district taxpayers some \$700,000.

Hypertension committee plans blood pressure tests

Plans for a mass-screening of area adults for hypertension continue to progress, but leaders of the project are concerned now about finding two ingredients essential to the project's success -- volunteer workers and blood pressure cuffs.

A community screening is scheduled for Feb. 9, through 14 under the sponsorship of the Plymouth Township, City of Plymouth and Canton fire departments, YMCA, Wayne County Health Department, Plymouth Registered Nurses Association and the Michigan Heart Association.

The idea for the project came from city Fire Chief George Schoenneman, who saw such a week set aside in Utah.

"Citizens there could go into any fire station during that one week of the year and have their blood pressure checked," said Schoenneman. "That's what we want to try here. We're going to start small in our three communities, but we'd eventually like to see it go throughout southeastern Michigan."

But placing several shifts of

volunteers in the area's four fire stations for six days will mean many people are needed. Schoenneman said.

While nurses and trained volunteers will actually check blood pressures, many others are needed to handle paperwork, pass out information and handle follow-up. Interested volunteers may contact Canton Fire Chief Mel Paulun, Plymouth Township Fire Chief Jim Gignac, Schoenneman or the YMCA.

Blood pressure cuffs are badly needed for greater efficiency in the screening process. Joan Goff of the Wayne County Health Department (WCHD) estimates the cost of such cuffs at about \$50, including stethoscopes. While the WCHD can supply a few of the cuffs, only a limited number are available to the project from other local sources.

Officials hope donation toward the purchase of blood pressure cuffs will come from local service groups and community organizations interested in seeing the hypertension week get off to a successful start.

"WE'D DO ANYTHING FOR YOU"

"No Kiddie without a Christmas"

Congratulations to Canton Goodfellows on their 25th year from the bank with 2 Canton offices to serve you

WAYNE BANK
FORD RD.

HAGGERTY RD.

GEDDES RD.
MICHIGAN AVE.
SHELDON RD.

Saturday banking too AND REMEMBER: FREE CHECKING IF YOU ARE 60 YEARS OR OLDER

	MON.	TUES.	WED.	THURS.	FRI.	SAT.
DRIVE IN HOURS	9:00-4	9:00-4	9:00-1	9:00-4	9:00-7	9:00-1
LOBBY HOURS	9:30-3	9:30-3	9:30-12	9:30-3	9:30-6	9:30-12

WAYNE BANK

100th YEAR



Chorus tunes for Christmas concert

THE PLYMOUTH COMMUNITY CHORUS will present a Christmas concert at First United Methodist Church Friday, Dec. 12 at 8 p.m. Thirty-five singers from the Plymouth area will

perform a variety of music ranging from contemporary carols to Brahms. Donations will be accepted at the door.

Schools pursue semi-annual tax

Representatives of Canton and Plymouth townships, asked by the Plymouth School Board to collect taxes in their townships twice a year instead of once as they do now, insisted last week that the schools study more thoroughly the costs and effects of the second collection.

The City of Plymouth already collects its taxes, twice yearly -- in December along with the townships and also in July. School administrators say that by collecting taxes twice a year, they would not have to borrow earlier in the year in anticipa-

tion of their December tax revenues, a procedure which currently costs the district an estimated \$100,000 annually in interest.

Canton Supervisor Robert Greenstein and Plymouth Township Trustee Dick Gornick, representing their townships on the Intergovernmental Committee, said last Wednesday that the schools should help determine how much such a move would cost the townships and what benefits school district taxpayers might expect to receive as a result of the change.

"The school district initiated this (proposal)," Gornick said. "If (the schools) can come up with a viable plan, we'll go along with it."



Green Plants give happiness.....
470 Forest
upstairs at
Forest Place Mall
459 - 2323

Garber to bench?

Plymouth Township resident James Garber, director of the Criminal Justice Institute and a former Wayne County prosecutor, has received official acknowledgement from the office of Gov. Milliken that he is under consideration for one of two vacancies opening soon on the Wayne County Circuit Court bench.

The retirement Jan. 10, 1976 of Judge George E. Bowles of

Plymouth Township and the state Supreme Court nomination of Judge James L. Ryan are expected to create the vacancies.

A letter of recommendation has been sent to Gov. Milliken on Garber's behalf by Plymouth Township Clerk Helen Richardson.

Garber said he expected the governor to announce his decision by Jan. 1.

Slaughterhouse operator acquitted of zoning charge

Canton slaughterhouse operator Dale Risinger has been found not guilty on a charge of a zoning violation in the expanded operation of his slaughterhouse located on Geddes Rd. west of Canton Center.

The six-member jury's verdict was announced last week in 35th District Court.

Canton Township Supervisor

Suspect charged

An 18-year old Plymouth Township man arrested at his home Nov. 24 has been charged with the armed robbery of a Northville drug store in which he disarmed two City of Northville policemen.

According to State Police, Gary Simon of 40419 Orangelawn is being held in Oakland County Jail in lieu of \$50,000 bond, pending his examination.

Police allege Simon was robbing the store when the two policemen entered without seeing him. He got the drop on them, police said, disarmed them and fled.

Bob Greenstein said Burt Burgoyne is preparing a civil suit against Risinger on behalf of the township. Canton is represented in the criminal action against Risinger by Township Attorney Walter Guth.

Planning terms expiring soon

Terms of three Canton Planning Commissioners are due to expire at the end of this month.

Carl Parsell, Thomas Timbario and Robert Simmons all are finishing terms Dec. 31. Parsell was appointed from the Canton Board of Trustees to replace Grant Campbell, who chose not to run again for the treasurer's post. Timbario was appointed to fill the spot of Joseph Kinnick, who resigned from the commission last year. Simmons is a long-time member of the commission.

Supervisor Bob Greenstein was expected to make appointments to the three positions at last night's board of trustees meeting.



BUSY BEE CRAFTS

1082 S. Main
(back in Stereorama lot)
455-8560

sign up!

*MACRAME & BASKETWEAVING			Mrs. Ohno
Mon, Jan 5	1-3 pm	5 wks.	\$12.50
Tues, Jan 6	10-noon	5 wks.	\$12.50
Tues, Jan 6	7-9 pm	5 wks.	\$12.50
*QUILLERY	Jan. 5	Monday	\$7.50
	(3 weeks)	Kit included)	
*NEEDLEPOINTE	Tues, Jan. 13	7 - 9 p.m.	\$15
	5 weeks		\$15
*NEEDLEPOINTE	Tues, Jan. 13	10-noon	\$15
	5 weeks		\$15

Pendleton
always virgin wool

MAKES GIFT GIVING EASY

- Sweater \$65.
- Slacks \$30.



NAWROT INC.
PENDLETON SHOP

In Forest Place Mall
470 Forest Plymouth 459 - 0440
22437 Michigan Ave. Dearborn 1142 N. Telegraph

Santa's Helpers are here and bustling about, Helping our shoppers day in and day out.



From now until Christmas come shopping with ease, we'll make it most pleasant, may we help you please?



Our children will be modeling at the Mayflower Brunch
December 14 9 AM - 2 PM

Toddlers 2 thru Pre-teen

Christmas hours:

Monday-Friday
10 a.m. - 6 p.m.
Saturday
10 a.m. - 6 p.m.

643 N. Mill in Old Village

The Clothes Tree



Trains dangerous, annoying One answer to C&O pains: dump Loop, build underpass

The C&O railroad's operations in our community are not only a nuisance, they're dangerous.

In the last four months, the railroad has had as many major derailments (which in one case force evacuation of an apartment complex) and a fatal crossing accident.

It is clearly time for our elected and appointed officials to take immediate steps towards eliminating the C&O's annoying, often unlawful and dangerous aspects of train travel through here.

City and township officials can cut down on the railroad's illegal crossing delays by applying pressure on the local district court to stiffen penalties for the C&O. The crossing problems seem to fluctuate — sometimes it's not so bad, lately it's been bad.

As it stands now, a plea entered by the C&O that mechanical failure caused a holding crossing gets the complaint dismissed by 35th District Court. In light of one C&O employee's statement to this paper that the railroad sometimes pleaded mechanical breakdown when that wasn't the case, the court should at least investigate the C&O claims.

(By the way, in case you didn't know, local and state laws prohibit trains from blocking a crossing for more than five minutes. If you are held up longer, note the engine or caboose number and report the offense to city or state police.)

But a more major decision must be faced by the city if the railroad problem is going to be permanently settled — construction of a grade separation at least one major rail crossing.

Even if, as the C&O claims, most crossing holdups are caused by breakdowns, they still block traffic, and an underpass for traffic would help tremendously.

The logical spot for one overpass, if that's all that can be built, is Main St. And the longer the matter is debated — the higher the cost will be.

With Malice Toward None

By W. Edward WENDOVER



After some 17 years of discussion, the yet-to-be-seen "Loop Road" is estimated to cost some \$600,000 to implement. It would be better to spend that money as the city's share of an underpass for Main and the C&O tracks.

Blocked crossings can mean more than inconvenient delays. Portions of the city and Plymouth and Canton townships can be blocked off from direct routes for emergency services.

And the delays themselves can be nerve racking. One businessman in Old Village — which is particularly prone to the C&O's whims — estimated that he must wait for five trains a day.

If the average wait is five minutes (balancing long and short waits), he would spend 130 hours a year of 312 business days — or more than five full days waiting for trains each year. Anyone who crosses and recrosses the railroad tracks in Plymouth can multiply it or her own yearly penance to the C&O. The railroad argues that it made this town what it is. Certainly rail transportation is important to our local industries.

But that doesn't mean we have to give the C&O a blank check — after all, it's one American railroad which is making money.

The 35th District Court need not feel leniency is in order for an impoverished defendant.

Estimated cost of a grade separation at Main Street is \$2 million. The city figures it can get \$1.4 million Federal and state funding to match its \$500,000 and \$100,000 from the C&O (the last of the big spenders).

By taking what is presently earmarked for the Loop Road, the city could cover its share of a railroad underpass and still have \$100,000 left to put up directional signs around the "Loop Road."

To get this issue resolved, the city should:

1. Instruct city police to vigorously enforce the five minute law on the C&O Railroad. Now that the commission will grant free downtown parking during the Christmas shopping season, transfer the ordinance officer to train duty. Ticket trains, not overparked shoppers.

2. Put pressure on the 35th District Court to get tougher on the railroad. The court should not jump to accept the C&O's story. Even when the C&O crossing tie-ups are caused by breakdowns, making the railroad answer up may force it to iron out its problems sooner.

3. Give the city manager and city engineer one month in which to update previous looks at the railroad problem

4. If the outcome of this study is like those of the past, which recommended grade separations, the city should begin looking for Federal and state funding to get the project under way.

5. Recommit "Loop Road" monies to a railroad solution. Why spend that much money helping traffic move more quickly and further from the CBD?

Wouldn't it be better to spend the money on something that may actually bring more people downtown? The wary drivers who now avoid Plymouth because of the trains might come into town if they could be assured of not hitting the same train four times. (It is possible when a motorist and a train proceed Northwest to southeast or vice versa their paths may cross FOUR times.) Forget the Loop — do something about the railroad.

Community Opinions

Page Six

December 10, 1975

'Rename Canton Twp. Plymouthue, Mi.?'

Editor:

The changing identity of Canton Township from a rich farm land to a fast-growing population expanse is posing a problem in postal mailing.

Some old residents wish to remain faithful to traditional Plymouth, Wayne Belleville or Ypsilanti post offices. To supplement this tradition, there are new residents who also would rather be listed under these prestigious cities.

With a city boom mushrooming in Canton, it is inevitable that the township must decide now to resolve the problem according to the wishes of the people. A separate ZIP code number of Canton is a convenient necessity, but whether the residents want to keep the name of Canton is debatable.

An interesting background at this moment would be to review the history of Canton and neighbors.

In what was called a "dismal swamp" because of the overflowing of the Rouge River and creeks like the Tonquish and Fellows — this was Canton Township. Through this territory, the Sauk Indian Trail, later called the Chicago Turnpike, the Pulaski Memorial Highway and now known as Michigan Avenue, wound its way from Dearborn to Chicago.

Canton, being the southern section of Plymouth Township, was proclaimed a separate territory by Act of Congress on March 7, 1834.

The name "Canton" was suggested by a Federal agent to honor the city of Canton in China, the object being to pick a name no other city had in the United States.

However, today there are several Cantons, including one not far away — Canton, Ohio. Therefore in view of this, the "name not found elsewhere in the United States" idea is null and void.

The name "Pekin" was suggested for what is now Plymouth, but, William Bartow, then a member of the territorial council appointed by Governor Cass, proposed the name of "Plymouth" as a more historical and patriotic title. Citizens further east changed their Chinese name to what is now Dearborn. Part of Nankin Township has become Westland.

The question arises: If Canton residents are not happy about the obscure name of Canton, why not change it to a more suitable name? Now is the time to act, before the post office arrives.

Since Canton originally was part of Plymouth, it is proper to be so included. Using Plymouth as prefix and "ville" from Belleville as suffix would make Plymouthville, but who wants to be called a "Plymouthvillian"?

Plymouthue would be more proper.

Voters could decide the name at the next election.
CHARLES ZAZULA
CANTON BICENTENNIAL COMMISSION MEMBER

Injustice marks a child's death

Whenever a child dies, those around him are filled with thoughts of how unfair such a death is.

In fact, the unfairness stretches out in several directions around such tragic circumstances: Why do parents have to suffer the added tragedy of bearing monumental medical expenses? How can such a loss of life ever be justified? Why does a child have to face death when he has barely experienced life?

Last week, Randy Aton, a nine-year-old Plymouth boy, died of leukemia, and all of those questions surfaced again. And yet, through the unfairness

of his death came a certain beauty, because of all the good things that came from the hearts of people in the Plymouth-Canton area who reached out to the Aton family.

Through the efforts of Cub Scouts and churches and civic organizations and even children, the Atons were spared a little of the unfairness of having to bear it all alone.

A final tribute both to the memory of Randy and to the willingness of one Plymouth organization to give came on Saturday, when Randy was buried. His funeral expenses were entirely covered by funds raised through a Vince Lom-

bardi benefit football game held several weeks ago at the Centennial Park Field.

So much needs to be said to so many people, and Edith Aton, Randy's grandmother, knows she could never say enough. But this deeply religious woman knows that the most important thing that happened was that Randy was a happy and satisfied little boy, although desperately ill, and to her and to Randy's parents — indeed to all of us, that is the "fairest" of all things anyone could have wanted.

KATHY KUENZER

the Community Crier

"THE NEWSPAPER WITH ITS HEART IN THE
PLYMOUTH — CANTON COMMUNITY"

447 S. Harvey St.
Plymouth, Mich. 48170

453 - 6900
Established 1974

Published by The Plymouth Community Crier, Inc.

General Manager W. Edward Wendover
Editor Hank Meijer
Photo Editor/Business Manager Robert S. Cameron
Sports Editor Dennis O'Connor
Feature Editor Kathy Kuenzer
Advertising Representative Frances Hennings
Circulation Manager Gina Carrington
Composition Supervisor Donna Lomas
Artist Cynthia Trevino



PUBLISHED EACH WEDNESDAY
Carrier Delivered: 50 cents monthly, \$6 yearly
Mail Delivered: \$10. per year.

HEIDE'S

PLANT SALE SAT. DEC. 13 ONLY

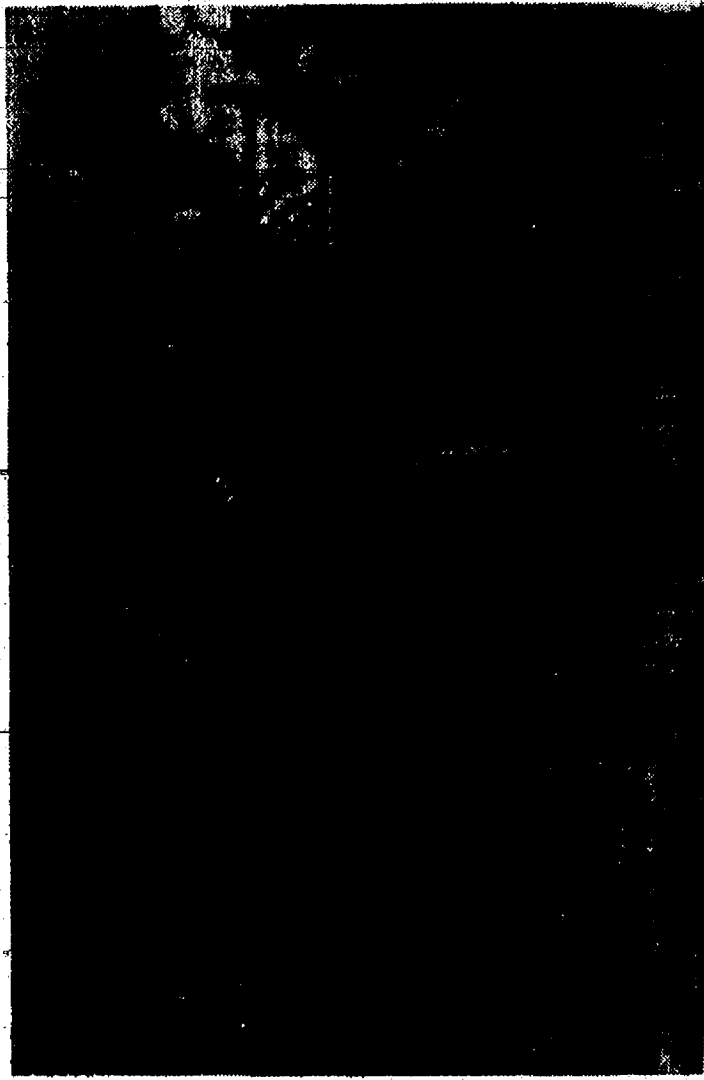

Norfolk Island Pine
The Perfect Christmas
gift 2ft. tree

ONLY \$5.88

453 - 5240

**POINSETTAS
ONE DAY SALE**



\$4.88

CASH & CARRY

For a very special
Christmas greeting
send the
FTD
**HOLIDAY
GLOW
BOUQUET**

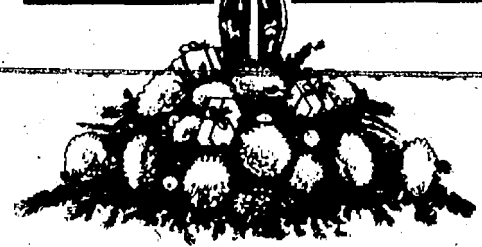

Nothing expresses the warmth of
Christmas like a living gift the
whole family can enjoy... espec-
ially this beautiful FTD Holiday
C Bouquet. You can send this
or one of our many other beautiful
selections, such as a poinsettia or
a Hanging Garden, to the people
you love. They are
special gifts every-
one will be glad you
sent. Call or visit
us today.



**REACH OUT AND TOUCH THEM
THE FTD FLORIST WAY**

**Call and
charge it over
the phone**

**DOUGLAS FIR
XMAS TREES**

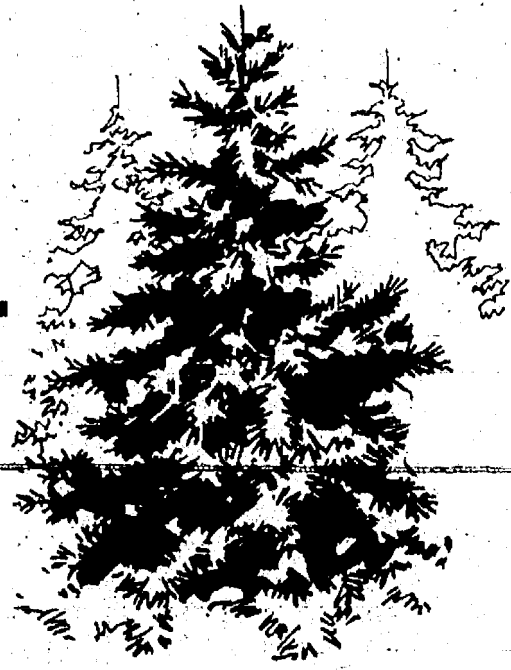

**ROPING - WREATHS -
GRAVE BLANKETS
STYLED YULE ARRANGEMENTS**

**Imported
plaques
Distributor
prices**

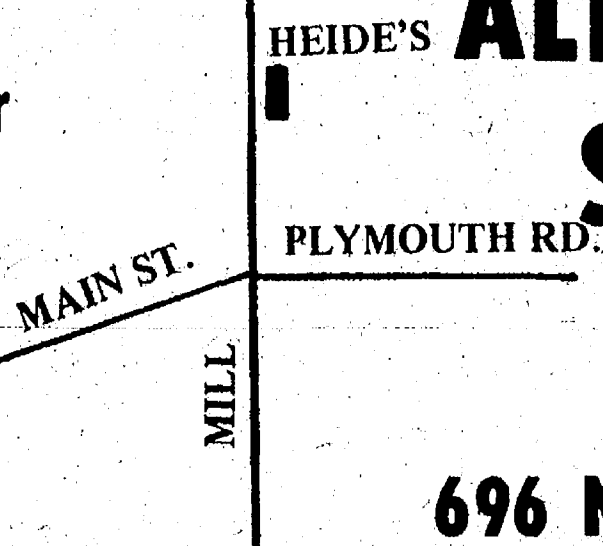

ALL GREEN PLANTS ON SALE

**SAVE
SAVE**

**GREEN PLANTS ARE
GREAT CHRISTMAS GIFTS**

696 N. Mill St. SAVE

WHEN YOU THINK HEIDE'S, THINK HEIDE'S OLD VILLAGE



COLONIAL CHEF has something for everyone

now featuring Soup & Sandwich Luncheon Specials, with two soups and chili daily.

WE HAVE ALSO ADDED
BREAKFAST SPECIALS

Children's Menu always available

Call Us For Your Catering Needs

WEDNESDAY after 5 p.m. is FAMILY NIGHT

FRIDAY is FISH SPECIAL DAY

SATURDAY after 5 p.m. is STEAK NIGHT

SUNDAY features ROAST CHICKEN & DRESSING

Colonial Chef Restaurant

New Hours: Mon. - Sat. 8-9 Sun. 8-8
278 S. MAIN - PLYMOUTH

Santa needs aid

Santa Claus may not arrive for many of the 100 children of women inmates at DeHoCo unless he receives some help.

The Lifeliners Auxiliary of the Plymouth Branch of the American Association of University Women, in cooperation with the Seekers Club, an inmate organization at DeHoCo, annually sponsors a Christmas Fantasy program which tries to provide one \$2 to \$5 gift for each inmate's child.

Gifts are then wrapped and mailed to the children in time for Christmas.

This year, the group needs help to insure that all 500 children will receive a present.

Groups or individuals who would like to assist in the project, either by donating money or gifts for boys and girls ages one - 16, should contact Mrs. Stephen VanderWeele at 455 - 7069.

Reunion planned

The Plymouth High School Class of 1956 is planning its 20-year reunion. All members of that class interested in participating should call 453-2046.

What's Happening

At 9:30 and 11 a.m. services Sunday, Dec. 14 the CHANCEL CHOIR of First United Presbyterian Church of Plymouth will present the Advent Cantata "Come, Redeemer of Our Race" by Johann Sebastian Bach. Soloists of the church will be featured, and instrumentalists will augment the organ accompaniment by Dorothy Crawford. Fred Nelson will direct the work that evening, beginning at 4:30 p.m. the congregation will make simple decorations and place them in the church hallways. This Decorama will be followed by a potluck supper and a color Christmas movie, "The Gentle Giant."

Members of the Plymouth Branch of the AMERICAN ASSOCIATION OF UNIVERSITY WOMEN (AAUW) will meet to enjoy an evening of CREATIVE EXPRESSION Thursday, Dec. 11 at 7:30 p.m. in the West Middle School Cafeteria. Activities will include a program of musical selections sung by the AAUW chorus, a display of crafts and other items made by members, and instructions for making spice rope hangers.

THE SALEM HISTORICAL SOCIETY will sponsor and OLD FASHIONED CHRISTMAS BAZAAR AND BAKE SALE Friday and Saturday Dec. 12 and 13, at Salem Township Hall, Six Mile and Dickerson. Hours Friday are 2 to 9 p.m., Hours Saturday are noon to 9 p.m. Included will be a craft show, candle dipping, quilting and spinning, a children's art show and a euchre tournament. Santa Claus and a puppet show will be featured Saturday from 3 p.m. to 5 p.m. and 6 p.m. to 8 p.m.

A meeting of the PLYMOUTH ASSOCIATION FOR THE ACADEMICALLY TALENTED will be held Wednesday Dec. 10 at 8 p.m. in Middle School East, 1042 S. Mill.

PLYMOUTH JAYCEES will hold a Merry Christmas GENERAL MEMBERSHIP MEETING Monday, Dec. 15 at 7:30 p.m. in the Mayflower Hotel. Young men between the ages of 18 and 36 are welcome to attend. If you need a ride, or want more information about the Jaycees, contact Phil Soper at 453 - 0831.

DELTA ZETA ALUMNAE Of Western Wayne County will meet Wednesday Dec. 10 at 8 p.m. at the home of Mrs. James Berry, 18568 Williams, Livonia, for a program entitled "The Joys of Christmas." The evening will feature a recipe exchange. Members are asked to bring canned goods and paper products for a Christmas basket, a Christmas card for a nursing home resident and a dozen cookies or hors d'oeuvres to exchange.

THE MAYFLOWER GARDEN CLUB will meet Thursday Dec. 11 at 10 a.m. in the home of Lorraine Jarvis. There will be an election of officers and discussion of 1976 projects. A Christmas card holder will be made.

THE PILGRIM GARDEN CLUB will meet Thursday Dec. 11 at 7:30 p.m. in Gallimore School 8375 Sheldon Rd. A slide presentation of the Grosse Pointe Christmas Walk will be presented.

SKI LESSONS will be offered with a choice of Saturday or Sunday classes starting Dec. 13 and Dec. 14 by the City of Plymouth Parks and Recreation. The nine lessons will be held at Mt. Brighton, along with recreation skiing. Rental equipment is available. For registration, contact the Recreation Department at 455-6620.

THE CANTON HIGH SCHOOL vocal music department will present a CHRISTMAS CONCERT Monday, Dec. 15 at 7:30 p.m. in the Salem High School auditorium. A variety of Christmas music will be performed. Admission is free.

The Sarah Ann Cochrane Chapter of the National Society of the DAUGHTERS OF THE AMERICAN REVOLUTION will meet at noon Monday Dec. 15 at the home of Mrs. Norman Suanders for Christmas Tea. Entertainment will be by the Canton High School Girls Madrigal Singers. Each member is asked to bring a gift for veterans.

Plymouth Northville Chapter 1311 of the AMERICAN ASSOCIATION OF RETIRED PERSONS will hold its monthly meeting Tuesday Dec. 16 in the Plymouth First United Presbyterian Church. Sewing, crafts and cards will begin at 10 a.m. A sack lunch at noon will be followed by a Christmas dessert and coffee furnished by the chapter. A Christmas sing-along will begin at 12:40 p.m. A short business meeting and installation of new officers will be held at 1 p.m. followed by a Christmas program at 1:45 p.m. Visitors are welcome.

SOLIDARITY FOR ECONOMIC EDUCATION AND DEVELOPMENT (SEED) will hold a Christmas Party Friday, Dec. 12 from 9 p.m. to 2 a.m. in the Plymouth Hilton Inn to raise money for purchasing economically educational filmstrips for use in Plymouth public schools. The party will feature hors d'oeuvres, a cash bar, dance band and a brief presentation of the Enterprise program of SEED. Tickets are \$10 per couple and are available from the Fish Barrel 455 - 2630, and at the door.

"A SUPER CHRISTMAS" is planned for youngsters on Saturday Dec. 13 from 2 to 5 p.m. in Our Lady of Good Counsel's gymnasium by teens of the parish. Parents may drop off their youngsters on that day while shopping. The donation is one can of food which will be donated to a worthwhile cause by the teens.



Gift
Certificate for Ladies
30 visits \$30
(includes use of all facilities)

TOTAL HEALTH SPA FIGURE SALON

459-4040

THE AREA'S MOST MODERN & COMPLETE EXERCISE CENTER:

- * Exercise room with over \$100,000 of exercise machines
- * Sauna
- * Baby Sitting facilities
- * Hair dryers
- * Showers
- * Group exercise

Total Health Spas, inc.



Across from Meijer Thrifty Acres in the TOTAL PLAZA

NOW OPEN

For the person who deserves a one-of-a-kind gift
Our shop features our own handblown glass items
— each one is unique.

Fri. Sat. & Sun. Noon - 5 p.m. 875 Wing just West of Main

GREEN'S GLASS



Delaware parcel to prompt Tanger response Shoebox finds way to Plymouth

A little bit of Delaware came to Plymouth last week -- in a shoebox destined for a Tanger School fifth grade.

And fifth graders in George Belvitch's class opened a present early, a sampling of tidbits and artifacts characteristic of Delaware.

Fifth graders at William Henry Middle School in Dover, Del. packed marsh water, leaves, newspapers, a weather map, shells, soybeans, clam shell, a pin of the state bird, bark, sand, tourist pamphlets, even a playtex glove made in the Eastern seaboard state, into the bulging shoebox, which was addressed to the Michigan Superintendent of Public Instruction in Lansing and forwarded to Tanger.

A letter from the Delaware teacher said packages sent out by his students last year were responded to by about 60 per cent of the schools who received them. This year he's hoping for 100 per cent return.

By all indications, George Belvitch's fifth graders won't let their Delaware counterparts down. Within minutes after opening the parcel, the youngsters were bubbling with plans for sending out a sampling of goodies native to the Wolverine state.

"We could even send them Plymouth Rock," said one exuberant youngster. Other suggestions included pond water and a Michigan license plate.

Whatever the fifth graders finally decide upon, a touch of Plymouth should soon be heading east.

CEP grads star

More than half of the cast of a recent Eastern Michigan University Theater production was made up of residents of Plymouth.

The musical-comedy "Dames at Sea", presented at EMU last weekend, featured Plymouth high school graduates Linda Dwyer, Cindy Carmody and Dennis Cockrum.

Band to perform

The Plymouth Community Band will present a Christmas concert at Westland Mall Wednesday Dec. 17 at 7:30 p.m.

Program music will range from the Baroque "Jesu, Joy of Man's Desiring," by Bach, too the more contemporary, "Sleigh Ride", by the late Leroy Anderson.

Director of the band is Bob Burr, a graduate of Plymouth High and a masters degree candidate at the University of Michigan with a major in conduction.

The Plymouth Community Band rehearses and performs throughout the year. New members are welcome to join rehearsals every Wednesday at Salem High School at 7:30 p.m.

the Crier's friends & neighbors



A SHOEBOX of surprises from a school in Delaware was examined carefully by members of George Belvitch's fifth grade class at Tanger School last Friday. Such Delaware originals as shells, leaves, marsh water and a weather map were sent to the school via the State Superintendent of Schools' office as part of a project of the fifth graders of William Henry Middle School in Dover, De. (Crier photo by Robert Cameron)

League aids local youths

Three area families and many local youngsters have benefitted as a direct result of Vince Lombardi Junior Football League Championship benefit games played this year at Centennial Park Field.

As hosts for the event, Plymouth Canton Lion and Panther junior football players, cheerleaders, coaches and parents all pitched in to make the holiday season a little brighter for the families of Jim Shinn, Joey Crissey and Randy Aton.

Total net proceeds from the game and associated activities amounted to nearly \$4,200 and have been divided equally among the three recipient families. Other beneficiaries include boys and girls at the Plymouth State Home, who have received donations of football, baseball and other athletic equipment valued at \$600.

Jim Shinn is familiar to those interested in Plymouth-Canton High School athletics as a young man who has refused to allow a tragic paralysis-causing accident to prevent him from contributing to the well-being of many other area young people.

Although confined to a wheel chair since his accident several years ago, Jim has devoted much of his time to coaching Canton and Salem high school athletes and serving as an inspiration to young people not directly involved with high school athletics.

Joey Crissey is another example of a young person who has

Cont. on Page 16

**The Holiday Party Season Again
Call Us for Steam
Carpet Cleaning**

ANY SIZE LIVING ROOM \$29.95

*FREE ESTIMATE
*AREA RUGS CLEANED
IN OUR PLANT
*See our fine selection
of new carpeting, too!

PLYMOUTH RUG CLEANERS, Inc.
1175 Starkweather
453-7450

NOTICE
TO THE EXPERT HAIR STYLISTS
IN OUR AREA

ENTRI HAIR SALON

NOW OFFERING
55% - 60% WITH YOUR OWN CLIENTELE

ALSO OTHER BENEFITS
All interviews will be confidential
Call for an interview

hair stylist
155-3100

Napier

ASK ABOUT OUR MONEY SAVING JEWELRY CLUB

TRIFARI

Choose from the widest array of these two leading jewelry style setting names.

The Cricket Box

THE HOUSE OF ELEGANT GIFTS

HOURS
MON. - FRI. 9:00 - 5:00
SATURDAY 9:30 - 5:00
SUNDAY 11:00 - 5:00

455 3332

IN THE OLD VILLAGE
 ITS
Bill's Market
 584 STARKWEATHER
PLYMOUTH
453-5040

GROCERIES - MEATS
 BEER & WINE TO TAKE OUT
 PARTY SNACKS • SANDWICHES • DELICATESSEN



Community Schools lunch menus

ALLEN
 Monday Dec. 15
 Chicken noodle soup, peanut butter and jelly, fruit cup, dessert, milk
 Tuesday Dec. 16
 Chicken salad sand., vegetable, fruit cup, brownie, milk
 Wednesday Dec. 17
 Sliced turkey, mashed potatoes, cranberry sauce, bread, butter, jello, cake milk
 Thursday Dec. 18
 Hot dog, relishes, bun, vegetable, fruit cup, cake, milk
 Friday Dec. 19
 Tacos, vegetable, bread and butter fruit cookie milk

BIRD
 Monday Dec. 15
 Chicken noodle soup, peanut butter and jelly, fruit, toll bar, milk
 Tuesday Dec. 16
 Pizza burger, green beans, fruit choc. cake milk
 Wednesday Dec. 17
 Hamburger gravy, potatoes, hot roll fruit milk
 Thursday Dec. 18
 Hot dog, bun, relishes, vegetable, fruit, brownie milk
 Friday Dec. 19
 Macaroni and cheese, vegetable, bread, jello milk

CENTRAL ELEMEN. & MIDDLE
 Monday Dec. 15
 Chicken noodle soup, crackers, peanut butter and jelly cheese sticks fruit milk
 Tuesday Dec. 16
 Hot dog, bun, relishes, beans, peaches milk
 Wednesday Dec. 17
 Tacos, corn, bread, jello, milk
 Thursday Dec. 18
CHRISTMAS DINNER
 Friday Dec. 19
 Tomato soup, crackers, grilled cheese fruit milk

FARRAND
 Monday Dec. 15
 Grilled cheese, tomato soup, toll bars, fruit, milk
 Tuesday Dec. 16
 Chicken in gravy over potatoes, pickle, rolls, fruit, milk
 Wednesday Dec. 17
 Ravioli with cheese and meat, cinnamon rolls, vegetables, fruit cup, milk
 Thursday Dec. 18
 Christmas Dinner, turkey in gravy over potatoes, cranberry sauce, bread, red and green jello, cake milk

Friday Dec. 19
 Fish sticks, tartar sauce, fries, bread, toll bars, fruit, milk

FIGEL
 Monday Dec. 15
 Vegetable beef soup, grilled cheese fruit, toll bar, milk
 Tuesday Dec. 16
 Hot dog, bun, relishes, green beans or sauerkraut, fruit, cookie, milk
 Wednesday Dec. 17
 Goulash, meat sauce, vegetable, bread, jello milk
 Thursday Dec. 18
 Hamburger, bun, catsup, fries, fruit, cake, milk
 Friday Dec. 19
 Fish sticks, tartar sauce, corn, bread, fruit, toll bar, milk

GALLIMORE
 Monday Dec. 15
 Chicken noodle soup, peanut butter sand., peaches, cake, milk
 Tuesday Dec. 16
 Grilled cheese, vegetables, fruit, toll bar, milk
 Wednesday Dec. 17
PARENT LUNCHEON
THIRD GRADE
 Turkey in gravy, mashed potatoes, rolls, green beans, jello cake milk
 Thursday Dec. 18
 Hot dog, bun, relishes, corn, pineapple, cake milk
 Friday Dec. 19
 Hamburger on bun, pickles, relishes, hash browns, ice cream, cookie milk

ISBISTER
 Monday Dec. 15
 Pizza puf, green beans, fruit cocktail, choc. chip cake, milk
 Tuesday Dec. 16
 Beef noodle casserole, peas, french bread, peaches, toll bar milk
 Wednesday Dec. 17
 Turkey in gravy over mashed potatoes, cranberry sauce, corn, ice cream, milk
 Thursday Dec. 18
 Hot dog, bun, beans, applesauce, cookie, milk
 Friday Dec. 19
 Grilled cheese sand., chips, yellow beans., fruit cup, milk

MILLER
 Monday Dec. 15
COOK'S CHOICE
 Tuesday Dec. 16
 Steamed frankfurter in bun, corn, fruit jello, cake, milk
 Wednesday Dec. 17
PIZZA!!
 Thursday Dec. 18
 Spaghetti with meat sauce, garlic toast chef's salad, fruit, cookie.
 Friday Dec. 19
CHRISTMAS DINNER
SMITH
 Monday Dec. 15
 Meat loaf, tater tots, cornbread, lima beans, peaches, cookie milk
 Tuesday Dec. 16
 Lasagna, bread, corn, cake, milk
 Wednesday Dec. 17
 Roast turkey, mashed potatoes, cole slaw, roll and jelly, cranberry sauce, or peaches, dessert milk
 Thursday Dec. 18
 Hot dog, bun, relishes, fries, cheese sticks, applesauce, cookie milk
 Friday Dec. 19
 Hamburger Dec. 19
 Hamburger, bun, relishes, carrots, pineapple, cake milk

TANGER
 Monday Dec. 15
 Grilled cheese, chill, crackers, fruit, toll bar milk
 Tuesday Dec. 16
 Fish squares, tartar sauce, potatoes, fruit, chocolate pudding, milk
 Wednesday Dec. 17
 Turkey w/ trimmings, potatoes, and gravy, rolls, jello, ice cream, milk
 Thursday Dec. 18
 Hot dog, relishes, vegetable, fruit, cake milk
 Friday Dec. 19
 Hamburgers, relishes, potatoe sticks, fruit, dessert milk

EAST ELEM. & MIDDLE
 Monday Dec. 15
 Chicken noodle soup, cheese sand., fruit, molasses cookie milk
 Tuesday Dec. 16
 Hamburger on bun, relishes, green beans, pudding, choc. chip cookie milk
 Wednesday Dec. 17
 Meat and cheese pizza, slaw, fruit, toll bar, milk
 Thursday Dec. 18
 Hot dog, bun, relishes, corn, fruit, banana cake milk
 Friday Dec. 19
 Fried chicken, potatoes and gravy, roll butter, jello milk

PIONEER MIDDLE
 Subject to change
 Monday Dec. 15
 Tacos, roll and butter, beans, sauerkraut, fruit milk
 Tuesday Dec. 16
 Hamburgers or cheeseburgers, fries, corn, fruit, milk
 Wednesday Dec. 17
 Sloppy joe, buns, vegetables, fruit, cookie, milk
 Thursday Dec. 18
 Meat and cheese pizza, salad, apple crisp milk
 Friday Dec. 19
 Fish sand, on bun, chips, vegetable, fruit, cookie, milk

WEST MIDDLE
 Monday Dec. 15
 Sloppy joes, green beans, pineapple cup, toll bar, milk
 Tuesday Dec. 16
 Meat and cheese pizza, corn, applesauce, toll bars, milk
 Wednesday Dec. 17
 Cream turkey, cranberries, mashed potatoes, cranberries, rolls and butter carrots, treat, milk
 Thursday Dec. 18
 Hamburger with trims, fries, OJ jello milk
 Friday Dec. 19
 Grilled cheese, salad, corn, fruit milk

CANTON-SALEM HIGH
 Monday Dec. 15
 Beef stew with veg., biscuit, honey, fruit, milk
 Tuesday Dec. 16
 Ham and Cheese on bun, vegetable soup, chips, dessert, milk
 Wednesday Dec. 17
 Hot dog, bun, beans, fruit, milk
 Thursday Dec. 18
 Fried chicken, potatoes, gravy, vegetable, sauce, jello, milk
 Friday Dec. 19
 Fish on bun or sloppy joe, chips, vegetable, fruit, milk

THE CAFETERIA STAFF WISHES YOU A MERRY CHRISTMAS & A HAPPY NEW YEAR!

SHOE BOOT

You bet! Our molded "Waco" provides warmth & waterproof protection



The Western look in a shoe boot by Stride Rite

Sizes: child's 10-4
\$13.50

KOBECK'S

Stride Rite Bootery

Sheldon at Ann Arbor Rd. - HOURS: 9:30 - 5:30 p.m.
 459 - 1070 Fri. till 8:30 p.m.



THERE IS NO FINER GIFT THAN A GIFT FOR THE HOME . . .

Art Craft Supplies
 Unfinished Furniture
 Wall Hangings
 Clocks
 Mirrors
 Lamps
 Wrought Ironware
 Wrought Iron Bells
 Children's Furniture
 Hex Signs
 Or A Gift Certificate

Be sure the paint you're buyin' is...
FULLER-OBRIEN



453-5100

Pease Paint & Wallpaper Co.

570 S. MAIN, PLYMOUTH Daily Mon. - Fri. 9-9 Sat. 9-6



Beitner's

fine jewelry

904 W. Ann Arbor Trail
 GL 3-2715
 Across From Mayflower 1/2 Block West



The DAMSEL

(Beauty Salon)

Save Time and Money
 Have Your PERMANENTS & FROSTINGS done during our Christmas Specials

Permanents reg. \$30	\$22.50
reg. \$25	17.50
Frostings reg. \$23	17.50

Senior Citizens on fixed incomes 1/2 off

453 - 3008 233 S. Main

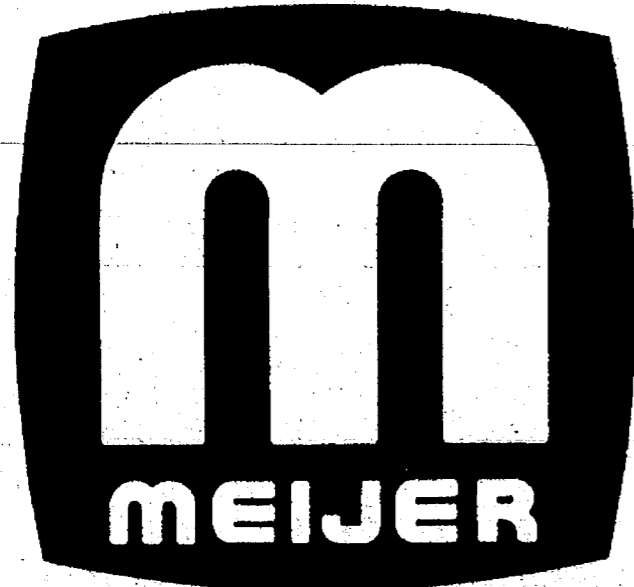

thrifty acres

1-STOP SHOPPING SAVES MONEY, TIME, ENERGY

A SAMPLE OF THE SAVINGS!



ANGEL HAIR

1-oz. wt. Box
Flameproof. Non-irritating spun glass. Our Reg. 54c.

39¢

TRIM-A-TREE DEPT.



VITAMIN C

100 Tablets
600 mg.

Our Reg. \$1.79

52¢ OFF WITH COUPON

PHARMACY DEPT.



MEN'S "JOHNNY CARSON" PAJAMAS

Coat or pull-over styles. Our Reg. \$6.96

\$4.96

MEN'S DEPT.

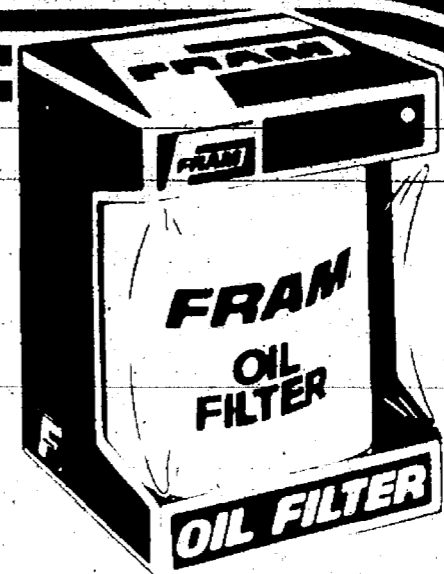

FRAM OIL FILTER

Sizes to fit most cars. **\$1.97** EA.

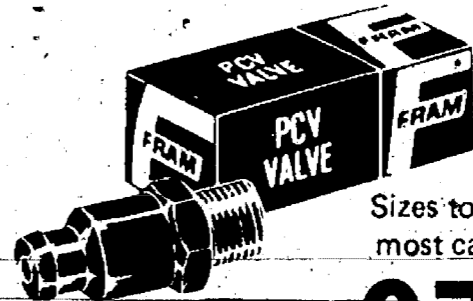

FRAM PCV VALVES

Sizes to fit most cars.

97¢ EA.

AUTO SUPPLY DEPT.

SMALL LEAN

SMOKED PICNICS

(WATER ADDED BY MANUFACTURER)

68¢ Lb.

PRICES GOOD MON., DEC. 8 THRU SAT., DEC. 13, 1975. MEIJER RESERVES THE RIGHT TO LIMIT QUANTITIES ACCORDING TO SPECIFIED LIMITS. NO SALES TO DEALERS, INSTITUTIONS, OR DISTRIBUTORS.

SAND-GROWN U.S. No. 1 NUTRITIOUS AND ECONOMICAL

MICHIGAN POTATOES

20-Lb. BAG

\$1.38

SOLID PACK GAYLORD MARGARINE

16-Oz. Wt. PKG.

4/\$1

MEIJER WHITE BREAD

20-Oz. Wt. LOAF

4/\$1

FAYGO - 6 Flavors & 4 Mixes

32-Fl. Oz. (Quart)

SOFT DRINKS

NR BOTTLE

4/\$1

THIS WEEK'S MEIJER 1-STOP SHOPPING GUIDE HAS AT LEAST \$39.12 WORTH OF COUPONS...GET YOUR FREE COPY IN THE STORE!



52¢ OFF COUPON

SAVE 52¢ with this coupon toward the purchase of: 100 Tablets - 600 mg.

VITAMIN C

Our Reg. \$1.79
\$1.27 With Coupon

52¢ OFF WITH COUPON

Good Mon., Dec. 8 thru Sat., Dec. 13, 1975

Coupon limited to one per item and per person. DEPT. 340

Meijer THRIFTY ACRES

27¢ OFF COUPON

SAVE 27¢ with this coupon toward the purchase of:

BEET SUGAR 5-Lb. Bag

88¢ WITH COUPON

Good Mon., Dec. 8 thru Sat., Dec. 13, 1975

Coupon limited to one per item and per person. DEPT. 419

Meijer THRIFTY ACRES

25¢ OFF COUPON

SAVE 25¢ with this coupon toward the purchase of:

FOOD CLUB CREAMY PEANUT BUTTER

48-Oz. Wt. Jar (3-Lbs.)

25¢ WITH COUPON

Good Mon., Dec. 8 thru Sat., Dec. 13, 1975

Coupon limited to one per item and per person. DEPT. 419

Meijer THRIFTY ACRES

31¢ OFF COUPON

SAVE 31¢ with this coupon toward the purchase of:

BANQUET FROZEN FRIED CHICKEN 2-Lb. Pkg.

\$1.47 WITH COUPON

Good Mon., Dec. 8 thru Sat., Dec. 13, 1975

Coupon limited to one per item and per person. DEPT. 419

Meijer THRIFTY ACRES

MEIJER THRIFTY ACRES — 45001 FORD RD. AT CANTON CENTER RD.

SHOP MONDAY THRU SATURDAY 8 A.M. TO 11 P.M. — SUNDAY 9 A.M. TO 9 P.M.

The Christmas rush floods Plymouth Post Office



4:30 a.m. AT THE LOADING DOCK



CARRIERS SORT YOUR MAIL BY STREET NUMBER

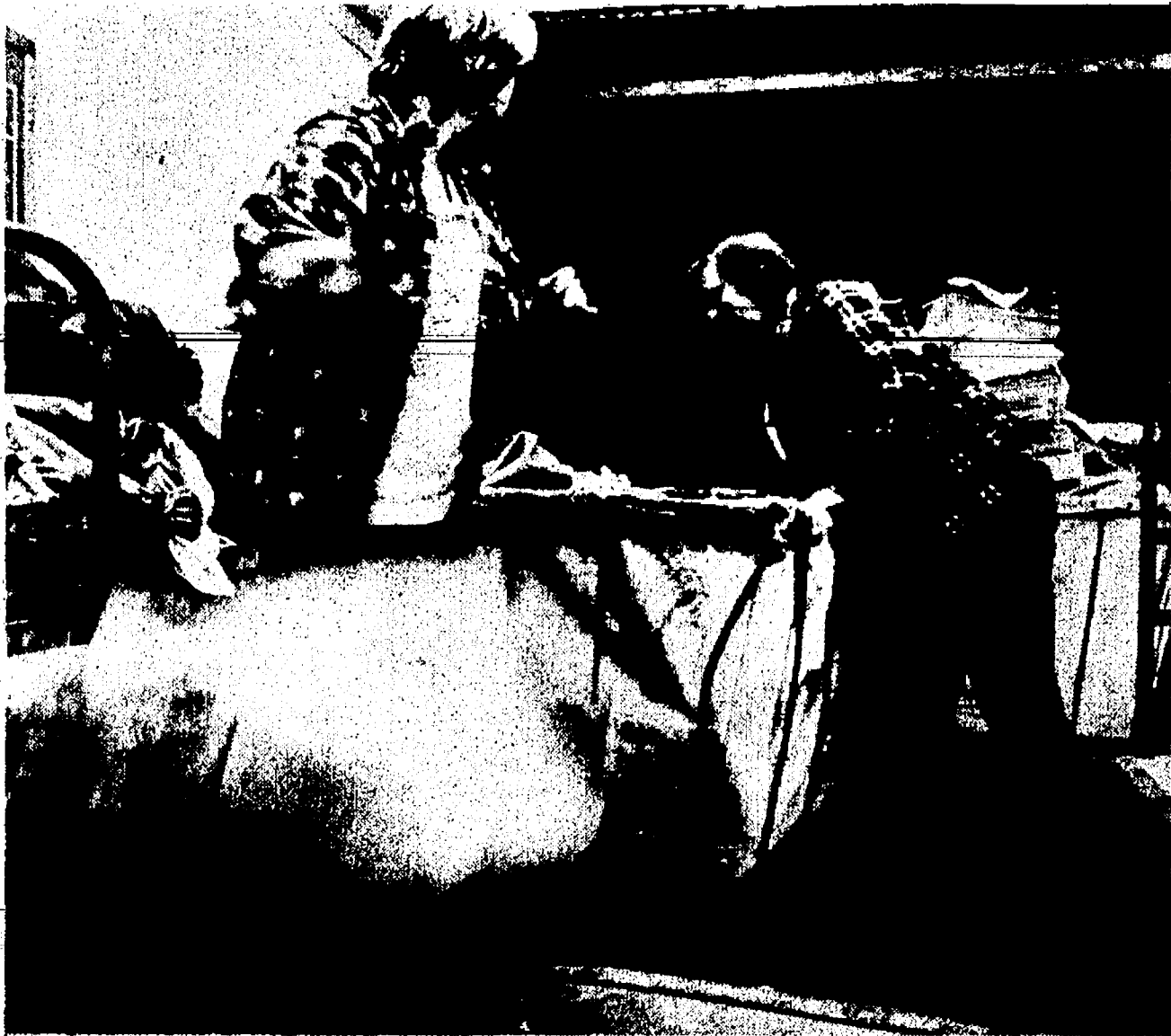

DISTRIBUTION CLERKS BREAK DOWN BAGS INTO ROUTES
OUT FRONT THE CHRISTMAS RUSH BUILDS



BY 3 P.M. IT'S WELL ON THE WAY TO YOUR DOOR



Crier photos by Robert Cameron



THE OLD GENERAL store in Canton's Cherry Hill community also served as the area's post office. Postmaster William West, his wife Louisa, and their children, Alfred and Berniece, posed for pictures at the store sometime around 1908.

Post offices of past flourished

Cont. from Page 1

because everyone thought they would cure the influenza."

West remembers there were only a couple "dozen or so" boxes for the "walk in customers." Mail was brought back from Ypsilanti by the man who drove the cream from Cherry Hill's creameries into Ypsi.

The small Cherry Hill General Store was remodeled into a house shortly after West's dad moved into a larger building west of the first building, but the house still stands where Ridge Rd. runs into Cherry Hill.

The old Canton Post Office at the corner of Sheldon Rd. and Michigan Ave. had as its postmaster and general storekeeper West's uncle, Frank Winsor. Winsor's wife was William West's sister.

Earl West doesn't remember

much about his uncle's store or post office, since he was born about the time the store was serving postal customers. But he dates a picture taken of the store as being from "around 1900 to 1910." Other sources remember that it became the "Sheldon" Post Office, sometime in the 1920's.

The general store, located next to the recently remodeled Canton Recreation Center, was only recently demolished.

West says his brother, Elton, who is interested in coins and how they help recall history, remembers there were "private" post offices in the area, also. Other Canton history buffs recall a post office on Denton Rd. near the railroad tracks.

Canton has seen its share of post offices. In those days, however, getting a new post office wasn't nearly so costly -- or so complex a process.

THIS POST CARD, postmarked at the Canton, Mich., post office in 1912, recalls a time when even a penny went a long way.

Canton resident Bruce Young framed a copy of this memorable postmark.

Dangerous intersection to get signals

A traffic signal adjacent to the Canton Fire Station is expected to be installed sometime this week, at the intersection of Canton Center and Cherry Hill according to Fire Chief Mel Paulun.

Paulun said Detroit Edison finished wiring for the lights this past week, and that an electrician will be installing a switch inside the fire station to

control the signals during emergency runs from the station. "Right now Wayne County (Road Commission) is just waiting for the signals to come in," said Paulun.

Won't you join us SUNDAY, DEC. 14th

Noon to 5 p.m. at

**SCHWARTZ'S
Greenhouse
Shop**

8201 LILLEY ROAD
(Between Joy & Warren)

**POINSETTIAS
from \$2.25**

**Browse through our
greenhouse displays**

call 459 - 2570

Daily 9 - 6
Sunday noon - 5 p.m.

Refreshments

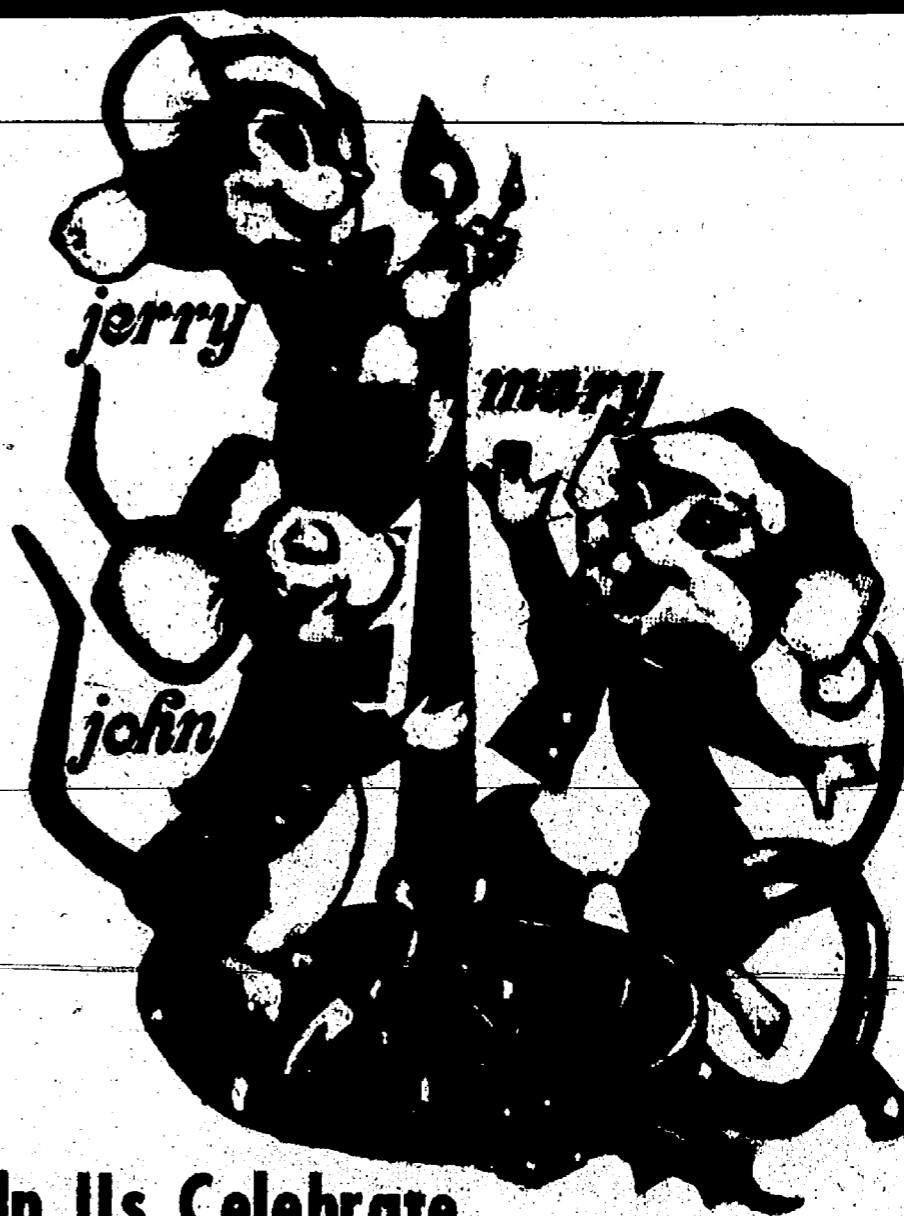

Help Us Celebrate

Our First Christmas

with

- * FRESH FLOWERS
- * GIFTS
- * PERMANENT ARRANGEMENTS
- * BLOOMING PLANTS
- * FOLIAGE PLANTS

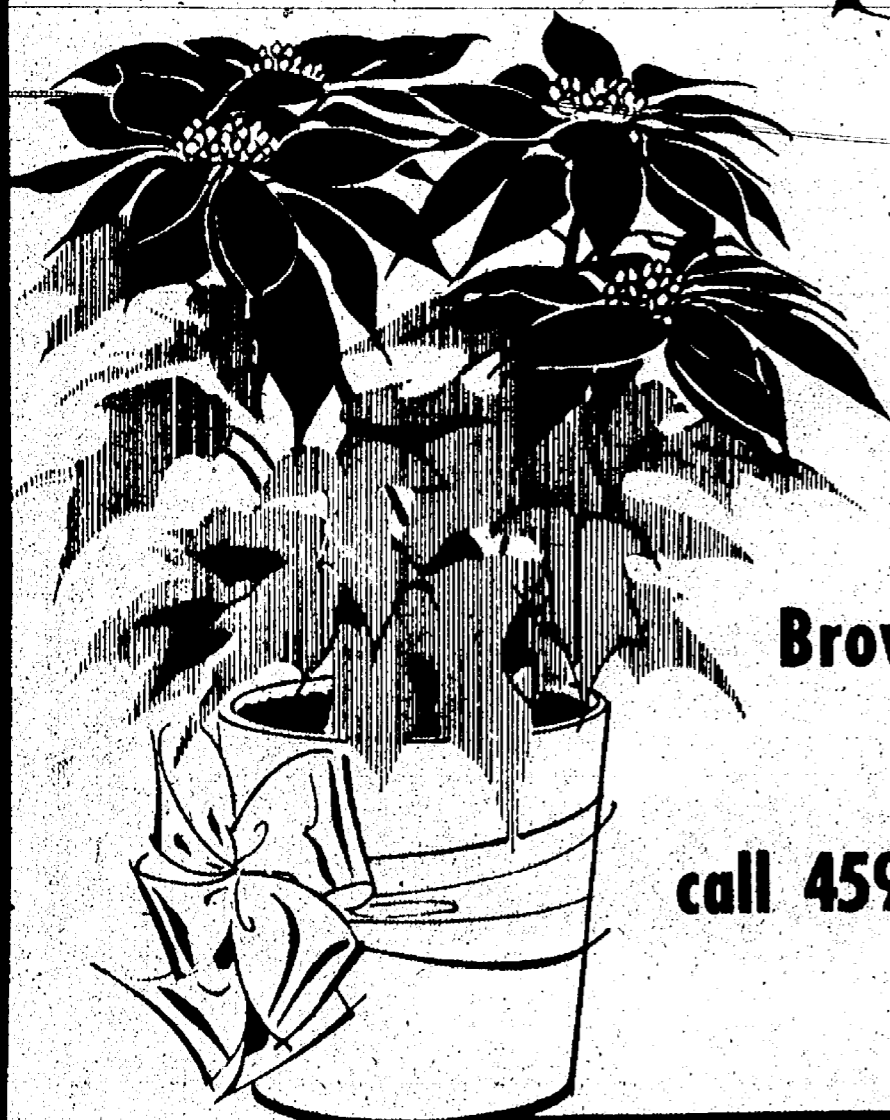
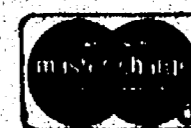
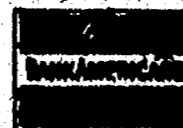



We will be
open for your
CHRISTMAS SHOPPING
convenience on
Sunday December 14th
and
Sunday December 21st
NOON to 5 PM

Minerva's Dunning's

WOMEN'S CHILDREN'S INFANTS
YARD GOODS 453-0080
Free parking in rear 500 Forest Plymouth



Fiegel hosts Santa, bazaar

THE PTO OF FIEGEL SCHOOL will present a combination "Gallery of Crafts" Bazaar and "Santa's Workshop" for children Saturday, Dec. 13, from 10 a.m. to 3:30 p.m. at the school. Macrame, cookie tree ornaments, a plant boutique, baked goods and many hand-made items will be featured, with all proceeds

to go to the PTO. Displaying some of the items to be sold are PTO members (from left) Buff Jarema, Bonnie Pawloski, Barb Schindel and Sue Beckwith, along with Fiegel youngsters Doug Campbell, Jeff Beckwith, Brenda Nickels, Julie Campbell, Michelle Beckwith and Bill Ahlgren. (Crier photo by Hank Meijer)

Play Santa!



Give the young people on your
list Membership in Plymouth's
own credit union. Start them
on a plan for financial security!

Your gift will be a lasting one,
and will increase in value
during the years to come.

**PLYMOUTH COMMUNITY
FEDERAL CREDIT UNION**
500 S. HARVEY



453-1200

**Central Elementary spellers
thrive using everyday words**

BY DONNA LOMAS

Second and third graders at Central Elementary School are becoming better spellers because the words they spell are those they hear and use most frequently.

Teachers at Central use coded word lists, beginning in lists of five words each for beginners and progressing to lists of 25 words each for older children. Students are encouraged to take as many lists as possible, and to master them as rapidly as they can.

"Since each child works with a tape, they are able to work at their own pace and that way do not have to slow down or try to keep up with classmates," said John Sharlhaas, who teaches third grade at Central. "I also teach skills - vowels and consonant sounds - to help the children recognize words more quickly.

"They go through the first four or five groups of words very fast," he said. "They've heard many already and use them in everyday speech (bike, car, dog, for example). These are easier to learn than a 'big'

word they haven't heard and won't have use for until later."

The International Graduate School of Education in Denver, Colo., first experimented with the theory that children should learn to spell those words which they and adults use the most.

Based on its research, IGSE indicates that out of some 18 million words in our language, 800 constitute 89% of all words written; a total of 2,650 words constituted 98.7% of all words written, and 10,000 words make up 99.7% of all words written.

Based on those findings, the researchers at IGSE determined that 2,650 words should make up the basic spelling list, and that if children should master those words during elementary school they "can be excellent spellers."

Sharlhaas made eight tapes for the 20 second and third graders participating in the program. He estimated it would take them to the end of December to finish the tapes. The tapes are 15 minutes long and according to Sharlhaas, "any longer would be ineffective."

"There are now five or six children who have finished the tapes ahead of schedule," he added. "I'm the one who has to keep up with these kids. I didn't expect them to finish so fast!"

Even though it means more work for Sharlhaas over Christmas preparing more tapes, he doesn't seem to mind.

"It works, that's what counts. Students are motivated to learn - that is one of the reasons for this program's success."

Sharlhaas stressed that IGSE'S program was not a remedial course. "It is a supplement to the regular spelling program at Central," he explained. "Those who use this program are doing very well."

Three other teachers are experimenting with the new spelling program. Others plan to start it next fall. Sharlhaas will continue to use it.

"It makes students want to learn," he said. "It makes learning more humane and productive - it works."

"Distinctive dining amidst colonial decor"

Hillside Inn

41661 Plymouth Rd. 453-4300 Plymouth, Michigan



AMATEUR ARCHEOLOGISTS in Mary Ellen Knopf's fourth grade class at Smith School unearthed an exciting historical "find" last week when they discovered a "time capsule" buried in the school's front lawn. Inside the capsule were such things as a metal candle holder (held by student in the center), a pair of spectacles and a quill pen. The students were led to the spot by a "document" found hidden in a dusty volume in the Smith library. Members of the school Bicentennial Committee gathered and buried the "artifacts" a few days before the class discovered them. A plan to bury another time capsule to be opened by members of the current kindergarten class when they become seniors in high school is planned by the committee. (Crier photo by Hank Meijer.)

Kids broadcast morning news

Every morning at 9 a "radio" news program is broadcast over the PA system at Gallimore School.

Learning consultant Sandy Schalenbrand, media specialist Kathy Schmidt, and fifth grade teacher Mary Lou Kroes help an entire fifth grade class collect, write, edit, tape and broadcast a daily radio program. The actual editing must be done between 8:30 a.m. and 8:55 a.m. every morning, so the five students who are "broadcasters" for the month have to hustle to meet their deadline. The other 25 students in the class serve as reporters, gathering and filing the news in folders, ready for the broadcasters to revise and edit the following morning.

The reporters' "beats" cover classroom news, weather, menus, messages from the principal, announcements from the main office, special school events, advertising and human interest stories.

There is always a "Bicentennial Blurb" - for example: "Michigan's new license plates have four stars on the left side. What do these four stars stand for? Listen to the end of this program to find out." Then at the end of the broadcast, the announcer repeats the question and gives the answer:

"The four stars stand for each country under which Michigan was controlled....France, Spain, Britain, and the United States."

Mac McDonald of CASTLES gave the youngsters pointers to get the radio station idea off the ground. Mrs. Schmidt and Mrs. Schaldenbrand met with the fifth graders in several sessions to discuss radio and broadcasting prior to the actual broadcast.

The project encompasses reading, public speaking, working under pressure, co-operation in group situations, operation of audio-visual equipment, editing writing and critical thinking.

What's New At WAYSIDE

Now's the time for stocking stuffers! We have the little Santa Soaps at .50 Bubble bath packets are always good. FINGER PAINTS for DIRTY KIDS are back again. Happy Shopping!

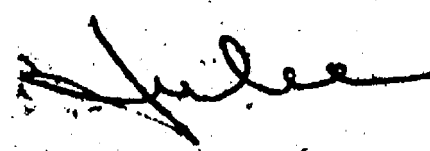

820 W. Ann Arbor Trail Plymouth

Computer alters Canton taxing

Canton Township Treasurer Carl Parsell has announced the beginning of a new system of collecting taxes in the township that should alleviate problems of both collecting taxes and distributing them to the proper agency.

According to Parsell, a mini-computer has been installed in township hall which will "not only keep all the money straight but will give a duplicate receipt outlining each charge, date and time, and also which clerk handled the transaction and a daily sub-total."

A "production line" of clerks will be on hand to check tax bills for errors, confirm that checks are properly written, accept payments and give receipts.

Hours when taxes may be paid at Township Hall are 9 a.m. to 5 p.m. Monday through Friday and 9 a.m. to noon Saturdays.

Taxes may also be paid at the following Canton locations: Wayne Bank, Detroit Bank and Trust, Bank of the Commonwealth, National Bank of Detroit, Security Bank and Standard Federal Savings and Loan.

Enjoy the Mayflower Hotel's famous SUNDAY Brunch and A Christmas Parade of Children's Fashions

presented by The Clothes Tree of Old Village

Bring your whole family to the **Mayflower Meeting House**
455 S. Main Street Plymouth

Sunday Dec. 14th 9 a.m. - 2 p.m.

Adults...\$3.50
6 to 12 yrs...\$2.50
under 6 yrs...\$1.00

Merry Christmas to all...

The Clothes Tree presents a **Christmas Fashion Show for Boys and Girls**
Toddler 2 thru Pre-Teen

Charming fashions modeled by our local children.

Michigan's Largest Selection of **FRYE BOOTS!**

FRYE

- All styles Western Apparel
- Blue Denim Specialists

SCOTT COLBURN SADDLERY
33365 Grand River at Farmington Rd., Farmington 476-1992

Call 453 - 1692 for reservations



OLD VILLAGE FLOWER SHOP
Flowers for All Occasions
640 Starkweather
(in Blunk's)
459 - 1290

Benefit aids youths

Cont. from Page 9

refused to allow physical impairment to dampen his spirit. Joey has many friends among the teachers and students at Plymouth area schools and throughout the community. His dad, Fred Crissey, is known for his coaching contributions to youngsters in the Plymouth-Canton community.

Randy Aton recently lost his hard-fought battle with leukemia. Monies intended to help him wage that fight are being provided to his family to help defray the financial burden of his long illness and death.

Perhaps the most unusual fact of the entire effort was the wide variety of fund raising activities associated with the game; the total reliance on volunteers backed up by community interest and the cooperation of local businessmen; and the additional support received by Vince Lombardi Junior Football league franchises in Ann Arbor, Brighton, Dearborn Heights and Allen Park.

Proceeds were derived from championship game ticket sales, advertisements purchased by local businesses for publication in a game program, concessions sold at the game, several raffles for donated merchandise, cash donations and the sale of restaurants coupons redeemable at local fast food outlets.

Each individual fundraising activity was conducted by an activity chairperson who supervised a committee of volunteer workers consisting of parents of players and cheerleaders participating in the Plymouth-Canton Lion and Panther Junior Football Program. Individuals responsible for the overall coordination of these many activities include Don Champagne, who served as director of fund raising effort; Ted Lazarchoff and Paul Meador, president and vice-president of the Plymouth-Canton Junior Football and Jim McDowell, commissioner of the Vince Lombardi Junior Football League.

On behalf of all those who participated in these fundraising efforts, these gentlemen would like to express their appreciation to all those who contributed to its success," said Champagne.



THREE CITIES ART CLUB held an exhibit of its work last week at the Plymouth Community Credit Union. Shown displaying one of her paintings is Audrey Paul of Plymouth.

SPECIAL CLEARANCE SALE
on all our name brand

FASHIONS BY **Boneta** OF PLYMOUTH

- *Bras
- *Slips
- *Undergarments

Special Holiday Hours:
Mon.-Thurs. Fri. till 8 p.m.
620 Starkweather
"in old village" 455 - 8121

State to run woman's jail

The state department of Corrections has taken over operation of the Detroit House of Corrections (DeHoCo) women's division on Five Mile Rd. in Northville Township. The move was authorized under legislation signed by Gov. Milliken in August which provided some \$200,000 for renovation of the 50-year old facility. The state is expected to relinquish operation of the institution in mid-1977, when a new \$10 million women's prison is slated for completion.

City suspends parking fees

Cont. from Page 1

In releasing that announcement Monday night, Mayor Joe Bida said six of seven members of the city commission had been polled on the matter and none had raised serious objections.

"It's a good gesture for Christmas," the mayor said of the free parking proposal, which is expected to win official approval at Monday's commission meeting. He lauded the commissioners for their spirit of cooperation in supporting the free - parking move.

"We're doing this providing we don't have problems," Bida said, adding that he hoped there would be no double parking or all-day parking space tie-ups.

"This is not something to expect every year either," he cautioned. "I gambled on this, I hope it brings goodwill downtown."

Bida said the city would likely lose about \$4000 in parking revenues.



ONLY 15 days left to shop for your Christmas diamond

Brilliant perfection in a Keepsake diamond to wear this Christmas and forever. Your love is reflected in its perfect clarity, precise cut and fine white color. With the famous Keepsake guarantee.

Keepsake
Registered Diamond Rings

Jeweler
Lippitt
Gift Shop

44570 Ford Road.
Canton
455-6860
(in KMart Plaza)
Ford at Sheldon

Hours
Mon. - Sat.
10 a.m. - 9 p.m.
Sunday
noon-5 p.m.

Plymouth Hilton Inn presents

WE'RE BUSTING WITH NEWS ABOUT **NEW YEAR'S EVE**

In the PLYMOUTH HILTON INN Grand Ballroom
8:30 p.m. - till 1:30 a.m.

ONLY \$49.95 PER COUPLE

RESERVATIONS 459 - 4500

Entire Evening's Party Package
Deluxe Prime Rib Dinner
Free Drinks all Evening
Dancing
Midnight Champagne Toast
Hat - Favors
Fun for All!

While you're here, stay overnight for only \$18.00 (double room)

BRING YOUR PARTY TO THE HILTON

TABLES OF SIX OR EIGHT SUGGESTED. LARGER TABLES ON REQUEST.

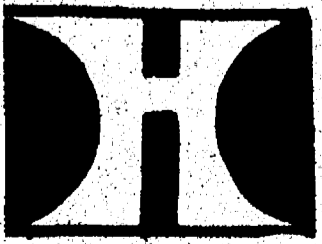

14707 NORTHVILLE ROAD
PLYMOUTH, MICH.

Teacher's dissertation holds promise for local school sites



SALLY DEROO

Big tires, places for kids to climb, inexpensive play equipment for youngsters of all ages and sizes — if Sally DeRoo's dream is realized, Plymouth schools could become models of careful site planning designed to make learning more effective and more fun.

The Canton High School teacher's plans for graduate study may soon blossom into a comprehensive study and development of school sites in the Plymouth Community School District.

Ms. DeRoo presented her proposal to the board of education and members of the school-district wide Intergovernmental Committee last week, and will soon be seeking approval from the city commission and the Canton and Plymouth township boards.

She envisions a project which would combine the talents of many agencies, chief among them several University of Michigan graduate departments which have expressed an interest in working on a model system for school site design.

At the heart of her proposal is creation of a core committee of university, school district governmental and public representatives who would set policy and priority for satellite committees of parents and teachers which would be organized at each school.

"This is an extension of something I've been interested in for a long time," she said. "Now I'm back in graduate school and it's an area I'm going to thrust into further."

The goal of her effort, she said, is "to develop plans for each school site — whether it calls for a park, a nature area or a tot lot — with the aim of actually developing those areas."

The result would be what she describes as "a web of sites that would offer invaluable learning experiences and unlimited resources.

"We'll know every school site, every piece of parkland, like the back of our hands," she said.

"What the project really does is make a near tie between the schools and the community and develop recreation areas for adults and kids.

"This is just the very beginning. At this time, there's no financial commitment at all."

"Naturally, a project of this magnitude will not happen unless we get Federal funds," she added.

Ms. DeRoo hopes to get Federal money to take advantage of interest in the project among faculty members in UM departments of education, landscape architecture and natural resources, and even among University of Pennsylvania educators.

Along with the project, U-M faculty members will offer local residents and teachers a two-

credit graduate class in school-site planning.

The class, which is scheduled for winter term if 20 or more students enroll, would meet weekly, each time in a different Plymouth school, at the convenience of students.

Local residents may also audit the course. For details, call Sally DeRoo at Canton High School, 453 - 3100 ext. 370, or the school board office at 453 - 0200.

What might come of the project? With Federal funds, Ms. DeRoo sees the plans and ideas graduate students and local committee members come up with being put into effect. — building of pocket parks, nature areas and other school site learning resources.

"I hope that in three years we can present planning for community use of all school and recreation land," she said. "The possibilities are all there, what we need is community support as well as school support."

Canton board studies traffic law ordinance

The Canton Township Board of Trustees was expected last night to consider an ordinance adopting the Uniform Traffic Code of the Michigan State Police.

Adoption of the ordinance would in effect make all state traffic laws also ordinances of the township. The auxiliary police unit to be formed in Canton

would also be given the authority to enforce such laws, with fines and costs for violations going to the township.

In the past several months the township board has passed several ordinances which may one day enable the township to operate an independent police department.

Spark Up Mealtimes!
with Exotic Dishes of
Indian, Italian and Middle Eastern Foods

Complete Line of Spices
Here's just a few!

- Juniper Berries
- Cassia Buds
- Zatar
- Annatto (Achiote) Seeds
- Hind Isheerie
- Kishk from Zahle
- Orris Root

Gift Items

- Brass Dishes
- Persian Drums
- Narghilas
- Kaftans
- Backgammon Boards

PREPARED Frozen Arabic Foods

CHEESE
from "Around the World"

MIDDLE EASTERN PASTRIES

- Baklava
- Kanafie
- Mammool
- Gurabia

AMERICAN ORIENTAL GROCERY
20738 LAHSER AT 8 MILE RD. • PHONE 352-5733
Open Mon - Thurs. 9-6, Fri. 9-8, Sat. 9-8 Closed Sun.

Paula Brooks
BRINGS YOU THE
ULTIMATE IN
CANDLELIGHT WEAR

A rippling long gown serenely elegant for magic hours. Multi-colored embroidery is showered on the Empire bodice and fully covers part of the graceful long sleeves. Revel in the softness and supreme comfort of wrinkle-free polyester knit, softly tinted in ideal season colors 6-16.

White • Yellow
Mustard
Multi-Colored
Embroidery

SANDY'S
MERLE NORMAN
BOUTIQUE

890 S. Main
455 - 9110

Little Angels
Come In Sizes....
Heaven to Seven



**little
angels shoppe**

Plymouth Locations

470 Forest
Forest Place Mall 459-1060

615 Mill Street
in Old Village 453-9451

Lions plan candy sale

PLYMOUTH LIONS and their assistants will be on local street-corners this Friday and Saturday selling Christmas candy canes to support projects that benefit those with impaired hearing and vision. Lion President Don Hay (standing) listens while candy chairman Dave Wood gives some sales tips to Julie Wood, Dana Flower, Julie Swain and Lisa Wood. (Crier photo by W. Edward Wendover.)



Now in Plymouth
HOURS: Thurs. 9-6; Fri. 9-9; Sat. 8-3:30

- **Unisex Hair Cutting and Styling**
- **Geometrical Hair Cutting**
- **Blow Cuts**

Done by Jim West
(formerly of Sir Edward)

Call for Appointment



**the
Cutting
Quarters**

459-0640 585 W. ANN ARBOR TR.
PLYMOUTH, MICH.



Newcomers spruce up park

PLYMOUTH NEWCOMERS CLUB brought the Yule tide spirit to Kellogg Park last Sunday, when they decorated the light poles with greenery. Husbands and wives alike assisted in the decorating project. (Crier photo by Hank Meijer)

Chamber to put out book

The Plymouth Community Chamber of Commerce is still seeking advertising for its all new Plymouth Pictorial Book. The publication is being completed by Graphic Communications of Plymouth. Business people interested in advertising should call the chamber office at 453-1540 or Bob Kollar of Graphic Communications at 455-4222.



the Viking
RESTAURANT & LOUNGE
INVITES YOU TO OUR
SANTA'S FESTIVAL BUFFET
Wonderful Fun For The Whole Family!

Thursday, Dec. 18th
5 P.M.— 10 P.M.
Christmas Carols

Holiday Inn®

BRING THE KIDS—LET THEM
TALK TO SANTA & HIS HELPERS.

\$3.95 adults
\$1.70 children
10 & under

SANTA'S HERE
With His Helpers
3812 WEST 10 MILE ROAD
at
GRAND RIVER in
FARMINGTON



477-4000

NEW YEAR'S EVE
ALL YOU CAN EAT & DRINK

Country & Western Entertainment
\$30 per couple
THE TAVERN

Northville Road between Six and Seven Mile
NOW BOOKING FOR DATES
In our new special addition to The Tavern
Private entrance, carpeted, spacious parking.
Facilities for 200 plus. Wedding receptions, banquets,
parties.

COMPLETE CATERING FACILITIES
FOOD SELECTION OF YOUR CHOICE
Call Will at 348-1173 for your reservations
Entertainment every Wed., Fri., and Sat. nights

Canton Jaycees aid recreation

The Canton Jaycees were expected last night to present a check for \$1,000 to the Canton Township Board of Trustees for use in developing the recreation site behind the town-

ship fire station at Cherry Hill and Sheldon.

Presenting the check to the board were to be Jaycee president Drew Rentz and internal vice president Bruce Roth.

Rentz earlier said the money represents the "first chance

we've had to help out in this way -- hopefully there will be more available throughout the year."

The Jaycees raised the money through the Jaycee Fair held in August and the recent Halloween Haunted House project.

Tony improves

A.C. "Tony" Licata, president of the Plymouth Civic Federation, was listed in satisfactory condition at St. Mary Hospital yesterday. Licata was admitted Nov. 20 following a heart attack at his Woodland Place home and had been in the hospital's cardiac care unit.

NOW OPEN
THE CLOCK



Family Dining
Breakfast 24 hrs.
9468 S. Main Plymouth



CEP Yule drive ends

A FOOD AND TOY DRIVE by students at Centennial Educational Park will brighten more than a few youngsters' faces this Christmas. Canton teacher and-coach Mike McCauley, one of the drive's organizers, checked through some of the donated good last week. (Crier photo)

Chamber touts tot toy drive

The Plymouth Chamber of Commerce through its retail division has announced its first annual Toys for Tots program.

The Toys for Tots campaign will allow local business people and residents alike to donate a toy which will be given to a child who would otherwise not receive such a gift this Christmas.

National Bank of Detroit, located at Penniman and Main, has placed a Christmas tree in its lobby as a gathering point for the toys. Toys may be left under the tree during regular banking hours.

Book fair nets Farrand \$150

The recent Farrand School Book Fair netted the school library \$150 to be used for the purchase of library materials. Nancy Wise is Farrand's librarian.

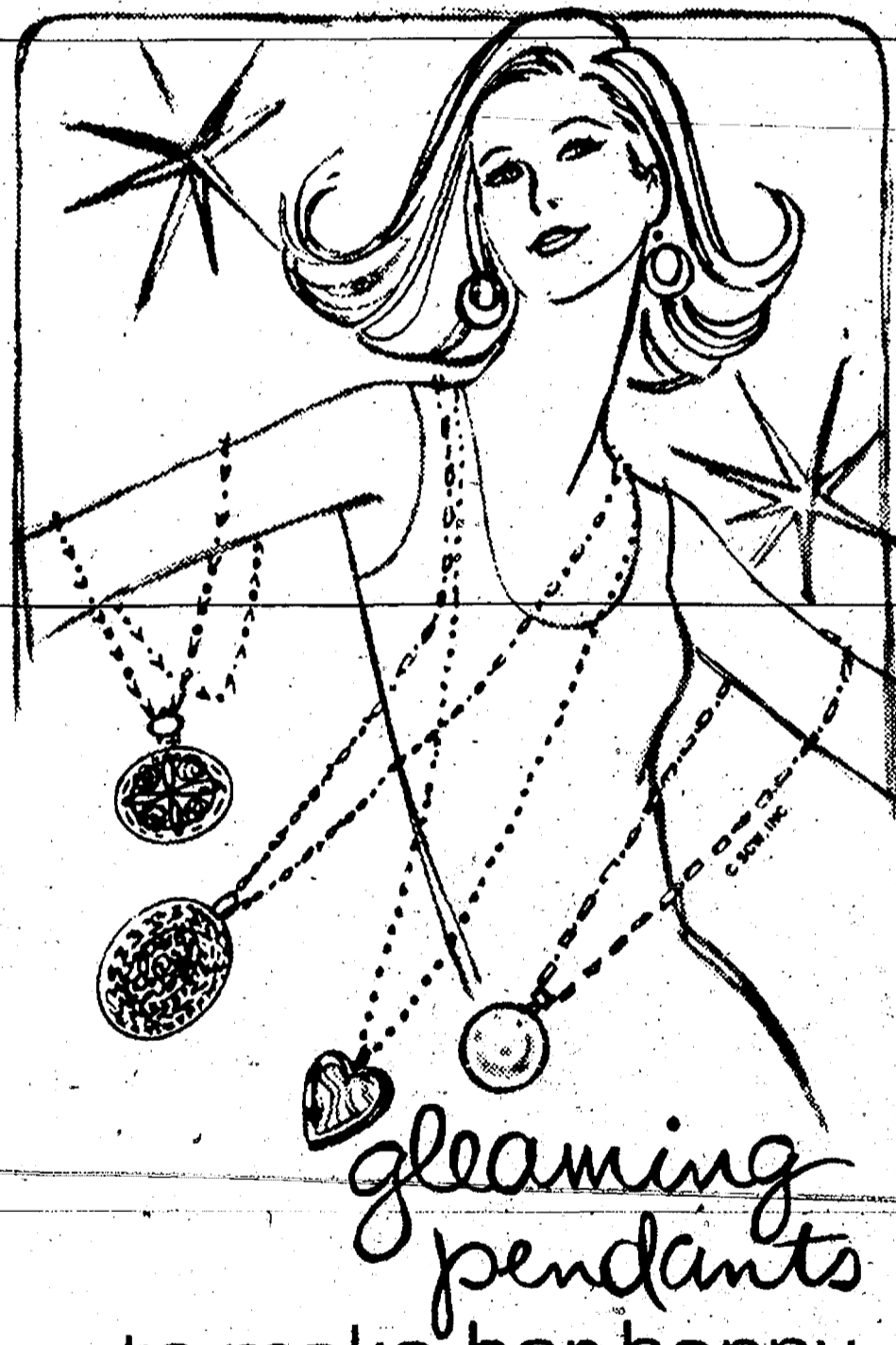

*gleaming
pendants*
to make her happy

Pretty pendants on swinging chains will delight that special lady on your list.

Charm her with...our evening bags.
Our tons of earrings.
Scarves Hats Gloves
and mittens

- *1928 Jewelry
- *Frilly umbrellas
- *Belts
- *Burlington hose and Rings & Things!



Mayflower Hotel 455-3311

PARTY PANTRY

CONVENIENCE
STORE

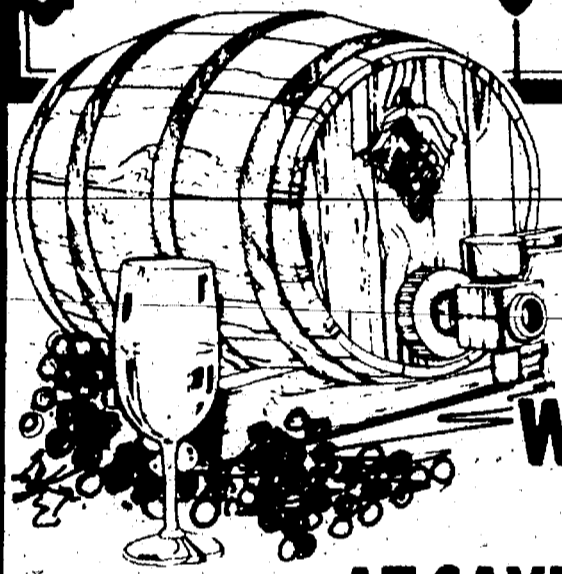

COLLECT
THESE FINE
WINE GLASSES

By Federal

AT SAVINGS OVER 40%

THIS
WEEKS
FEATURE:
12 OZ.
BRANDY SNIFTER

REG. 59¢
39¢ each
WITH ANY
PURCHASE

EXCLUDING ALCOHOLIC
BEVERAGES & TOBACCO
PRODUCTS

COLLECT ALL
THESE FINE
WINE GLASSES
AND
SIX COMPLETE
PIECES

REG. PRICE
WHEN NOT ON
SALE 59¢

SCHEDULE:		
DATE	ITEM	PRICE
DEC. 8	12 OZ. BRANDY SNIFTER	* 39¢ ea.
DEC. 15	8½ OZ. ALL PURPOSE WINE	* 39¢ ea.
DEC. 22	5½ OZ. SPARKLING WINE	* 39¢ ea.
DEC. 29	6 OZ. DESSERT WINE	* 39¢ ea.
JAN. 5	12 OZ. BRANDY SNIFTER	* 39¢ ea.

* FEATURE PRICE WITH ANY PURCHASE!

OPEN 7 a.m. to 1 a.m. - 7 DAYS A WEEK!
45002 FORD ROAD AT CANTON CENTER ROAD
AT THE MEIJER THRIFTY ACRES

DON'T BUY

a tree until
you see ours
**LIFELIKE
TREES**

FROM

\$9.95

SAXTON'S

TREE & TRIM SHOP
587 W. ANN ARBOR TR.

453-6250

Gifts that get things done ...

B&D Black & Decker®



© HWI
Mr. Friendly



B&D Black & Decker **MOD 4** **Cordless System**

FREE LANTERN HEAD

with PURCHASE OF MOD-4 UPRIGHT GRASS SHEAR AT **29⁹⁹**

UPRIGHT GRASS SHEAR trims easily ... without bending. Chrome-plated connecting handle. Converts to hand-held shear. Includes Energy Pak Recharger and tool and accessory holder. 8921

LANTERN HEAD operates with MOD-4 Interchangeable Energy Pak and Recharger. Connects in a second! Ideal for camping or boating. Gives up to 2 1/4 hours on a single charge.

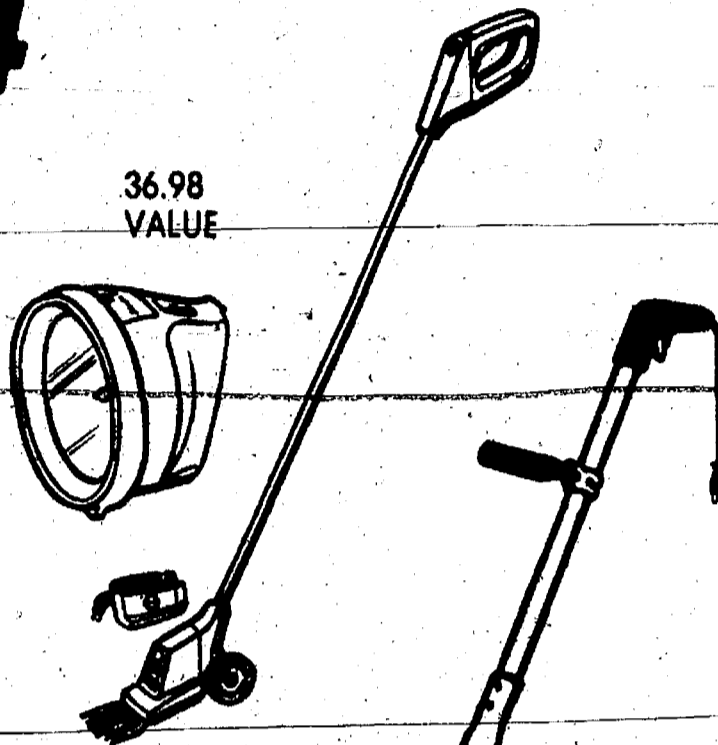

36.98
VALUE

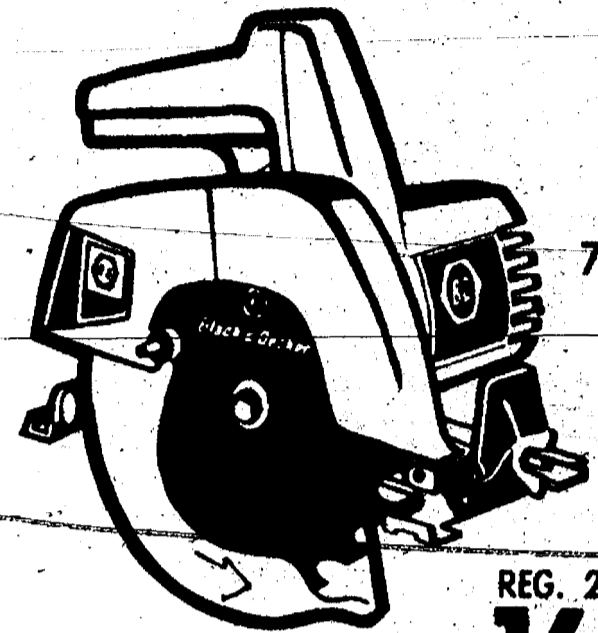

7301

REG. 24.99
7 1/4" SAW 16⁹⁹

1 1/4 HP saw makes bevel and depth adjustments easily. Ejection chute keeps sawdust away from cutting line. Includes 7 1/4" blade.

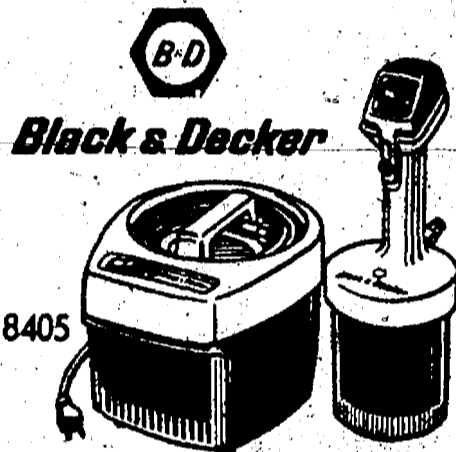

Black & Decker

8405

AIR COMPRESSOR

with **SPRAY GUN**
Use for painting, spraying or inflating. Includes spray gun, compressor and inflator kit.

44⁹⁹

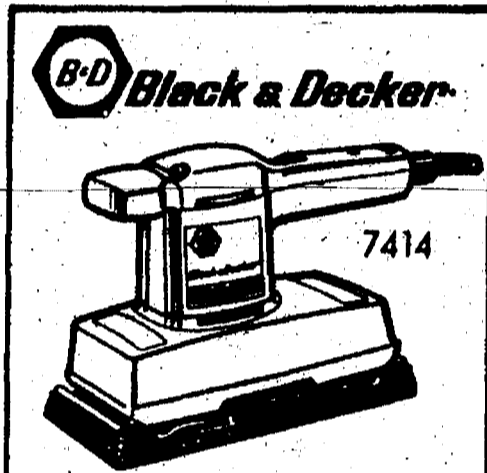

Black & Decker

7414

FINISHING SANDER

Double insulated, orbital action. 6 foot detachable cord. 25 HP.

16⁹⁹

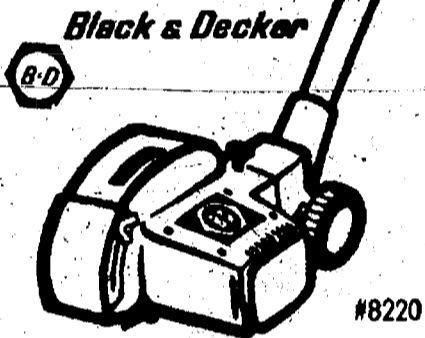

Black & Decker

8220

DOUBLE INSULATED LAWN EDGER & TRIMMER

Clean-cutting 8" winged blade. Release knob allows easy conversion from edging to trimming.

44⁹⁹

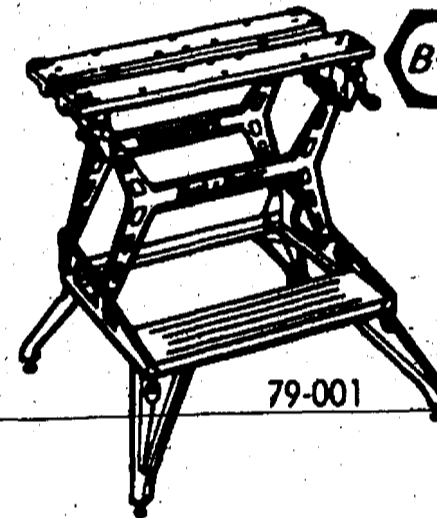

Black & Decker **Workmate** **WORK CENTER**

Completely portable unit sets up anywhere, in garage, workshop or at the worksite. V-grooves and pegs grip irregular and tubular objects. Adjustable vise jaws. Folds to 29 1/2" x 7 1/2".

SALE PRICE **79⁷⁷**

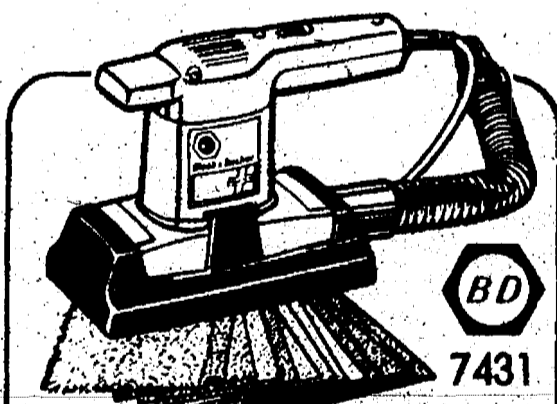

BD
7431

SANDER ASSORTMENT

A dust-collecting sander and polisher. Includes sander, attachment, pad and sandpaper.

19⁹⁹

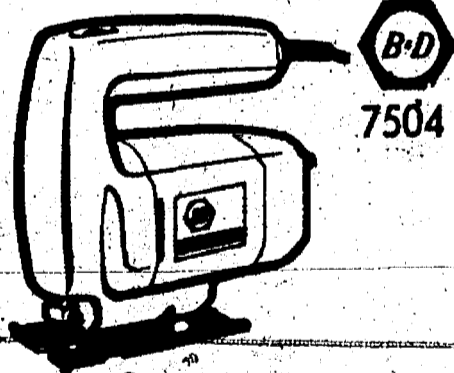

BD
7504

SABRE SAW

Double insulated, versatile timesaver makes straight, curved and scroll cuts in wood, metal and plastics.

REG. 12.99
10⁸⁸

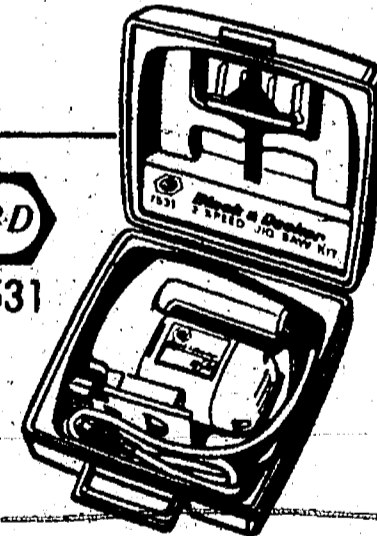

BD
7531

2 SPEED JIG SAW

Low-and-high speed jig saw kit includes saw, rip fence, 4 assorted blades and fitted plastic carry case.

19⁹⁹



BD
7181

3/8" VARIABLE SPEED DRILL KIT

Good for screw driving! Kit includes drill, chuck key, 3 drill bits, 5 sanding discs and cotton buff in case.

29⁹⁹



PLYMOUTH HARDWARE

453 - 0323

515 Forest In downtown Plymouth

Eli, team bust records

Rocks maul RU, Franklin

BY JOE PIERCE

Jim Ellinghausen pumped in a school record 43 points Friday night to lead the Salem Rocks basketball team to a 79-70 victory over Redford Union on the opponent's court.

The Sub-8 league opening victory raised the Rocks's record to 3-0 for the season.

Ellinghausen eclipsed the old mark set by Tim VanWagoner, who scored 39 points in a contest against a Redford Union team in the 1972-73 season.

Ellinghausen scored 31 of his points in the first half, many of them coming on 5 and 20 foot jump shots and driving lay ups.

Salem jumped out to an early 14-6 lead and finished the quarter ahead 20 to 15. The Rocks ran their offense to near-perfection in the second quarter, as they outscored the Panthers 28-17 and went into the lockerroom at intermission with a commanding 48-32 lead.

In the third quarter it was all Salem as the Rocks raced to a 20-point advantage, 64-44.

At the 7:03 mark of the final quarter, Ellinghausen hit a 22-footer from the left side for the record, and raised the Salem lead to 66-48. At that point, Salem coach Fred Thomann cleared his bench. In the next four, Redford Union outscored the Rocks 20 to 10 to close the gap to 74 - 64.

the Crier Sports

The Rocks then stalled to preserve their victory.

After the game, Thomann said, "We did a good job sticking the ball in the hole, but we still didn't play good defense."

Tom Ellinghausen, Jim's younger brother, was the only other Rocks cager to score in double figures.

He notched 12 points and Howard Inch chipped in with 8. Forward Mike Primeau pulled down 10 rebounds. Guard Brian Wolcott, in foul trouble all night, had 6 assists.

While Ellinghausen was breaking the individual scoring mark on Friday, the team as a

whole surpassed a scoring mark three days earlier, romping to a 94 - 59 non-league victory over Livonia Franklin.

The old scoring record for any Plymouth team was 93 points, set against Allen Park in the 1970 - 71 season.

But reserve Chris deBear put an end to that four-year old mark, as he calmly sunk two free throws with 59 seconds left to give the Rocks their 93rd and 94th points.

Ellinghausen led the Salem scoring attack with 33 points to go along with his 12 rebounds. He has scored 100 points in his first three games.

Cont. on Page 25



CANTON CAGER Rob Mandle drive past a Farmington opponent for two of his eight points in last Friday night's loss to the Falcons, 47-40. The Chiefs will attempt to rebound from that poor performance Friday, when they open their Western Six League Schedule on the road against Churchill. (Crier photo by Robert Cameron)

Salem matmen cop AP tourney

BY DENNIS O'CONNOR

What better way to start the first week of wrestling competition than to win a tournament? That's exactly what the Salem grapplers did, walking away with the first-place trophy last Saturday in the Allen Park Invitational.

The Rocks matmen topped the host Jaguars by 16 points to win easily the eight-team tournament. Clarenceville finished third behind Allen Park.

Plymouth captain Carl Schultz, wrestling at 126 pounds, pinned two opponents and won the championship in his weight class on a decision, as he was voted the invitational's most outstanding wrestler.

Les Hassen (112 pounds) grabbed a first place finish with two pins and a decision victory in the finals.

Dave Champion (185) took three victory decisions, the last

being a 2-0 win, to place first in that weight class.

Dave Kolb was the fourth Rock top medalist, taking the heavyweight division by pinning two opponents and winning the championship with an 8-6 decision.

Greg Harper (155) and Richard Constantino (143) were strong performers for Plymouth, each taking second place honors.

Rich Suanders and Rene Leist each placed third, while Bob Dasher and Dave Scrugg grabbed fourth place finished to round out the Plymouth scoring.

"We did real well, I'm very pleased, but there still is a lot of work to be done," said coach Ron Krueger after the victory.

The work that has to be done is preparation for the all-important Suburban Eight League opener with rival Edsel Ford this week.

The Rocks opened the regular dual meet season two days before their tournament victory, and fell to a tough Westland John Glenn team 40-17 in a non-league match.

The most impressive showing for Plymouth came from the first three wrestlers, Leist, Terry Ward and Hasse, who all picked up victories.

Ward's hard-fought 13-6 decision was the top Plymouth performance of the night.

After that quick string of victories, the Rocks were practically shut out the rest of the way, except for a victory by Champion and a tie for Harper.

The 7-3 decision in Champion's favor came over Glenn's Mark Grabowski, who competed in the regional last season.

Sloppy Chiefs fall to Falcons

It was a game plagued by too many turnovers and poor shooting.

The difference was that the Canton Chiefs made more turnovers and shot worse than Farmington, resulting in a 47-40 win for the Falcons.

The loss was the second of the young season for the Chiefs against no victories (not including last night's results at Belleville). Canton opens its Western Six league schedule Friday night against Churchill on the opponent's court.

With the score deadlocked at 4-4 after the opening four minutes of action, Canton opened up and maintained a

four-point margin for the rest of the period.

A 25-foot jumper at the buzzer by junior guard Rob Mandle gave the Chiefs a six-point edge, 14-8, after the first eight minutes of play.

The second quarter featured sloppy play by both teams, turnover after turnover after turnover, missed shots after missed shot. The result was a 7-4 second quarter margin for Farmington which cut the Canton lead to 18-15 at halftime.

Time and again, both teams would go down the court and miss a shot, throw a bad pass or commit a costly violation.

As coach Casey Cavell continually substituted to try to find the right combination on the court, the Chiefs went without a field goal until Bill Parson popped in a 15-footer from the right side with only 1:22 left until halftime.

Canton hit only one of 12 shots (8%) in that period, shooting only a 25% mark at halftime.

The Chiefs were able to maintain their three-point margin through the first three minutes of the third period before the roof fell in for good.

With the score 22-19, Farmington suddenly reeled off 14

Cont. on Page 25

IT'S FUN!
TO EAT AND DRINK
at...
Little Caesar's Family Inn
1492 SHELTON RD. at Ann Arbor Rd.

SPAGHETTI
\$1.99

Children 10 and Under only .99
Served Sunday thru Thursday until
9 PM only!

ALL YOU CAN EAT!

Choice of 3 Gourmet Sauces, includes salad,
and our famous garlic bread.

FREE
Buy any
Buy any medium
Pizza
at regular price,
get identical medium
pizza FREE.
Ann Arbor Rd. at Sheldon
Carry Out only
Good thru Tuesday, Dec. 16 **453-1000**

Canton wrestlers fall in Bentley opener

BY MATT NORRIS

The Canton grapplers were overpowered by Livonia Bentley in their first dual meet, 45-19, Dec. 4 on the foe's mat.

The Bulldogs won seven of their eight matches on pins after Canton captured victories in the first two weight classes.

Several Chief matmen were competing in their first dual meet, but coach Dan Chrenko was pleased with the performance of freshman Dave Durkin, sophomores Bob Yauck and Scott Collins and junior Bill Heedum.

After Durkin (98 pounds) won and Heedum (105 pounds) took a major decision, four Canton wrestlers suffered pins. Three of the four pins came with less than

40 seconds to go in the third and final period.

Collins handled his Bentley opponent, the fall coming in the first period. Canton trailed 24, with five matches left in the meet. The Bulldogs gained three pins and one winning decision between the 145 and 185-pound divisions, clinching the score at 45-13.

Yauck pinned Bentley's heavy-weight 32 seconds into the match, ending the contest 45-19.

Chrenko said, "I was disappointed with the number of pins, but we showed we can wrestle and compete well."

Canton will wrestle at Franklin tomorrow (Dec. 11). Franklin should be tough in the 119, 126, 132 and 138 pound classes.



AN IMPROVING Canton wrestling team lost its first meet of the season last Thursday at the hands of Livonia Bentley, but showed promise

that it could rise in the standing as the season progresses. (Photo by John Gaffield)

Jack Gray is president

New athletic board chosen

Board members for 1976 were chosen last week by members of the Plymouth-Canton Community Junior Athletic Association (PCCJAA).

Heading the executive board is President Jack Gray. Vice-president is Larry Masteller, financial vice-president, Janet Brass, treasurer, Jim Sinclair, and secretary, Jeanne Goodrich.

Other voting members on the board -- which represents the four sectors of Plymouth-Canton junior athletics -- include Paul Denski (baseball), Ed Kenyon (hockey), Ted Lazarchoff and Dick Molyneaux (football) and Dave Abram (basketball).

The Plymouth-Canton Junior Community Athletic Association is a non-profit and volunteer organization servicing youngsters in the Plymouth School District.

It was created for junior football in April, 1967, and extended its membership immediately to baseball and basketball. In the fall of 1970, junior hockey was given membership.

The PCCJAA's purpose is to sponsor and promote organized sports activities for the youth of the Plymouth-Canton community and to promote citizenship, sportsmanship, fellowship, and physical development.

Last year, an estimated 27,000 volunteer hours went into the four-sport program.

Full cooperation with recreation groups, local municipalities, service clubs, community funds, the community school system and all other helpful individuals is encouraged.

Anyone interested in getting involved with the PCCJAA may join any of the four sports programs.

Suburban 8 standings

Plymouth Salem	1 0 x	Friday's Results (Dec. 5)	
Dearborn	1 0 x	PLYMOUTH 79, Redford Union 70	
Trenton	1 0 x	Allen Park, 71	Edsel Ford 63
Allen Park	1 0 x	Trenton 65	Belleville 56
Belleville	0 1 1	Dearborn 61	Bentley 52
Redford Union	0 1 1	WESTERN 6 LEAGUE	
Edsel Ford	0 1 1	(Action starts this Friday, Dec. 12)	
Bentley	0 1 1		

Sports Happenings

Wed. Dec. 10	NO ACTION		
Thurs. Dec. 11	C. 9 Basketball	Marshall	T 4 PM
	S. Wrestling	Edsel Ford	T 6:30 PM
	C. Wrestling	Franklin	T 6:30 PM
	C. Swimming	Annapolis	T 4 PM
Fri. Dec. 12	S. 9 Basketball	Northville	H 3:30 PM
	S. JV Basketball	Trenton	H 6:30 PM
	S. Varsity Basketball	Trenton	H 8:15 PM
	C. JV Basketball	Churchill	T 6:15 PM
	C. Varsity Bsktball	Churchill	T 8:15 PM
Sat. Dec 13	S. Wrestling	Thurston	T 10 AM
	S. Swimming	RU Relays	T --
	C. Swimming	RU Relays	T --
Mon. Dec. 15	NO ACTION		
Tues. Dec. 16	S. JV Basketball	Fordson	H 6:30 PM
	S. Varsity Bsktball	Fordson	H 8:15 PM
	C. Swimming	Ypsilanti	T 7:30 PM

the captain's table
(formerly the Drawbridge)
Chico (host) Allan Hughes (executive chef)

ENTERTAIN FRIENDS here during the Holidays

Complete Seafood Dinners \$7.50 or \$10.50

- * Soup * Salad * Potatoes
- * Shrimp Cocktail & Coffee or tea
- Live Maine Lobster

PRIME RIBS & STEAK

OPEN:

TUESDAY THRU SUNDAY Casual Attire

"- Inventive - Intriguing" New York Post

"- a playwright, a composer, everything." Detroit Free Press
"Multi-Talented Composer"



BOBBY LAUREL THURS., FRI., SAT.

No Cover Charge Dancing Reservations

349-4885

145 N. Center Northville



GIVE HIM EUROPE

This Christmas give him European fashion in a slack that offers style and versatility. Tailored with the continental touch in polyester comfort.

GLEN OAKS™

slacks \$20

Express Dinners M. Charge BankAmericard FREE GIFT BOXING

Famous MEN'S WEAR

The Store that "fits" in Plymouth 924 W. Ann Arbor Trail 453-6030

Hours: Daily 9 - 9 Sun. noon - 5 p.m.

Frosh win

It was no contest from the start as the Salem freshmen basketball team rolled to their first victory of the season, 71-40 over Clarenceville.

The Rocks are off this Thursday but will take their 1-0 record against Marshall in two weeks.

Coach Pat Cunningham used 16 members of his bench as 10 were in the scoring column.

The Rocks were led by 18-point performances by Matt Etienne and Kevin Kelliger.

Bring back gear

Plymouth Panthers and Lion members who haven't turned in their equipment from the past junior football season should contact Jim Sinclair at 11449 Terry; 453-7114.

OPEN HOUSE

SUNDAY 1 - 4 p.m.

6345 HAGGERTY (bet. Ford & Warren) Just reduced. Face Brick, 1 1/2 story, 4 bedrooms, new garage, alum. sided, 3.66 acres.

\$72,900

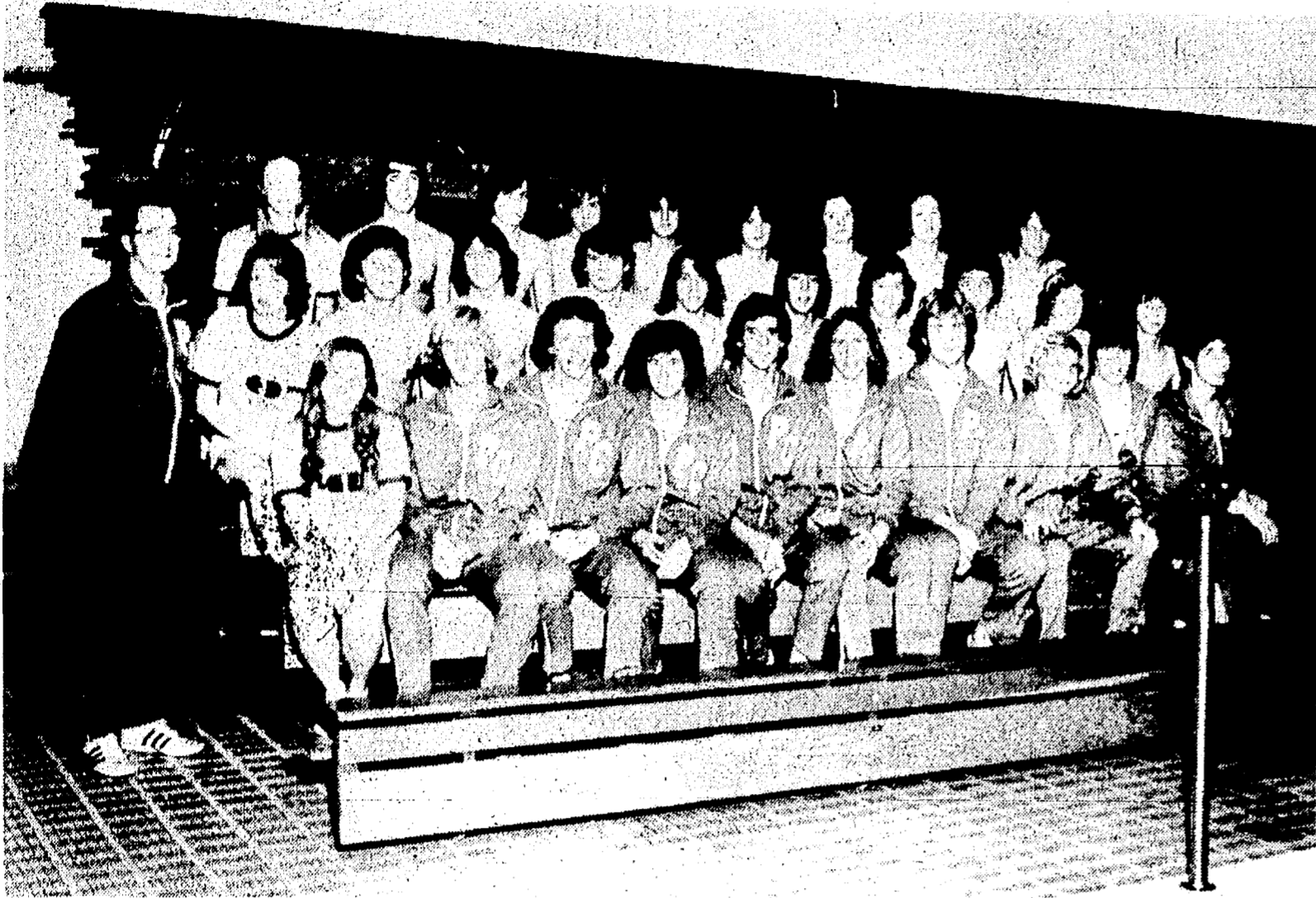

THE YOUNG AND INEXPERIENCED Canton swim team lost its opening dual meet to North Farmington last Thursday night, but

the Chiefs could improve when they open their Western Six League competition in two weeks. (Photo by John Gaffield).

Harris, Wales head efforts Tankers soaked in opener

The opening of the dual meet swim season was an unfortunate one for the Canton Chiefs, as they were dunked by a strong North Farmington squad, 120-151 in non league action last Thursday.

"They're deep from top to bottom," said coach William Faunce of the Farmington team that has won the Northwest Suburban League swimming title in its last two seasons.

Outstanding juniors Kevin Harris and Scott Wales paced point production for the Chiefs. Harris grabbed the first-place finishes in the sprint races, as he won the 100 and 200 respectively event with times of 53.1 and 1:56.8 respectively.

Cage standings

Cent. 21	3	0	x
Wagenschutz	2	0	1/2
Master Collision	2	0	1/2
VisCom	2	0	1/2
Little Caesars	2	1	1
Christian Brothers	1	1	1 1/2
Richardsons	0	3	3
Box Bar	0	3	3
Independents	0	4	3 1/2

Chief frosh roar, 65-26

The Canton freshman basketball team breezed to victory in its season opener Friday racing past Hilbert of Redford Union 65-26.

Hilbert held an early 5-1 lead, but it was all Canton after that, as the Chiefs romped to a decisive 25-7 margin after the first period of play.

They extended that lead to 39-14 at halftime, and held their opponents to only two points in the third period, rolling to a 53-16 advantage going into the final eight minutes of action.

Coach Fred Crissey cleared his bench of 17 players, and 15 Chief cagers got into the scoring column.

The balance scoring attack was led by Kurt Herbert's 14 and Jay McKinley's 12. Rusty Mandel added eight, with several players popping in six each.

Wales was a decisive victor in the diving competition with a total of 198.20 points, 50 better than his closest competitor.

Other impressive opening meet showings by the Chiefs saw freshman Tom Simrak place se-

Rock swimmers dunk hapless Thurston

"We've started off fast this season, picking up and improving from last year's times," said a pleased coach Byron Williams following his squads 108-64 shellacking of Thurston in a non-league meet last Thursday night.

It was an impressive way for the Rocks to open the season, as they took nine first place finishes in 11 events.

Tom Smith and Ron Finley were double victors in leading the Rocks to victory.

Smith won the 200 and 500 freestyle races with times of 1:57.1 and 5:26.0 respectively.

Junior Finley swam a 2:10.9 in the 100 individual medley and a 52.4 second respectively.

Tom Griffin swam a 2:10.9. Bill Cholpan (100 back) and Mike Stocker (diving) were the other individual first place winners.

Plymouth also won the two relay races. Cholpan, Steve Kohler, Steve Lazarus, and Craig Richter took the 100 medley relay, while Mike Etienne, Tom Robaeue, Ritcher and Finley teamed up to win the 400 free relay.

cond in the 500 free and senior-Tim Greenleaf take second in the 100 breast.

Sophomore Steve Wood chipped in with a third-place finish in the 100 butterfly.

An inspired foursome of sophomores nearly took second in the 200 medley relay, losing to the top Thurston foursome by a hair.



Give him a
HOMELITE
CHAIN SAW...

HOMELITE 150 Automatic Chain Saw

- Powerful 2.6 cubic inch engine.
- 16" Power Tip®-guide bar.
- Big saw performance at a sensible price.
- High performance, rugged construction, lightweight.

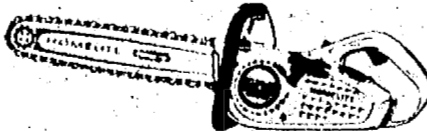

FREE - Carrying Case

CANTON POWER EQUIPMENT

453-0295
46600 Ford Road
one half mile west of
Canton Center Road

Northville
Charley's
COME ON OVER AFTER THE MICHIGAN STATE & MICHIGAN FOOTBALL GAMES!
DINNER 7 DAYS
LUNCH M-F
41122 WEST 7 MI. RD. 349-9220
NORTHVILLE

The Deck & Den Shoppe
7387 Lilley at Warren
"EVERYTHING YOUR LITTLE HEARTH DESIRES"
Custom Made Fireplace Screens
Gas Grills Gas Lamps Gas Logs
Sales Service Installation
455-7080

MING'S
5840 North Sheldon
Harvard Square
"The Finest Cantonese & American Dishes"
Luncheon and Dinner
Mon-Thurs. 11 AM-11 PM
Fri-Sat. 11-12:30 Sun, 12-10 PM
Carry Out Banquet Facilities
459-0271 5840 N. Sheldon

Stork's FOTO EMPORIUM
Harvard Square (Ford and Sheldon Roads)
MON.-SAT. 10-9
SUN. -12-5
OUR STUDIO AND DARKROOMS ARE OPEN NOW FOR YOUR USE
Visit our gift department
up to **40% off**
The Pocket Camera for you or the perfect gift for someone—
Keystone Everflash
110 Pocket Camera
Has its own built-in electronic flash, never needs flashcubes!
Plus these features:
■ Color corrected 15.6 lens
■ Double exposure interlock
■ Large bright viewfinder
■ Saves up to 15¢ per flash picture
\$39.95
SALE ENDS SUNDAY, DEC. 28

'Loans' underwrote inventory students' boutique opens for business

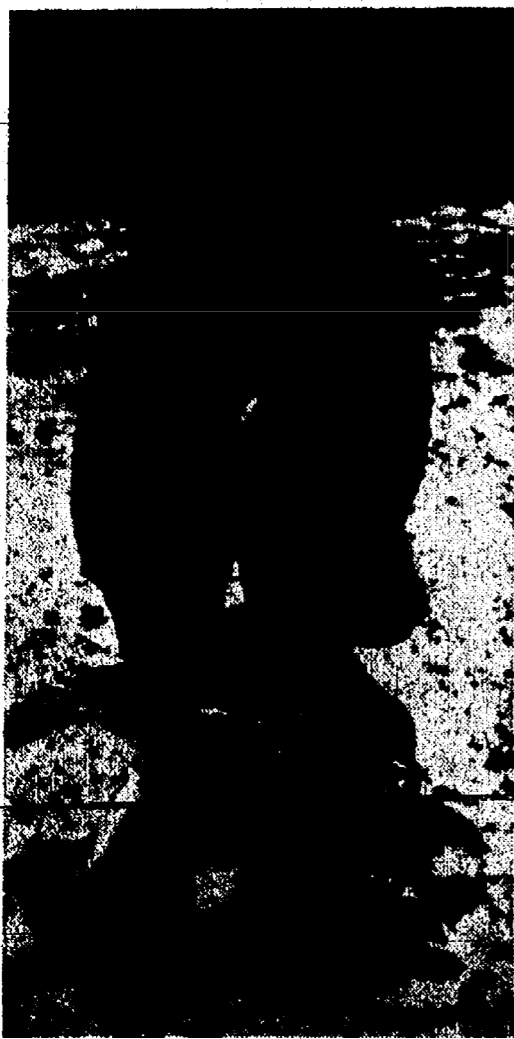

LEROY STULTS, of Plymouth bagged his biggest rabbit ever Tuesday off Napier Rd. Stults, a member of the Western Wayne County Conservation Club, was hunting with friend Dale Petty when he shot the six and three-quarter pound animal. (Crier photo).

Young businessmen and women in the second grade at Bird School will find out tomorrow whether or not their newly-established business will be a success.

That's when the second grade classes of Delores Smith and Sandy Wilcox open up "shop" and their Kid's Stuff Construction Company holds a Christmas Bazaar (Thursday) from 6:30 to 8:30 p.m. in the front hall of Bird School.

Kids' Stuff Construction was organized earlier this fall as part of a unit in career education in the second grade rooms. To understand exactly what a businessman (or woman) must do to start a business, the classes floated loans of \$20 each at the First National Bank of Plymouth. With the loans they bought supplies for making items to be sold at the Christmas bazaar.

Using their profits they plan to pay back the loans and give salaries to the Kids' Stuff Construction Co. employees -- the second graders themselves.

Included among the bazaar items are pieces of original art, stick puppets, decorated soap, candles, piggy banks and Christmas decorations.



Newcomers win royal treatment

THREE MEMBERS of the Canton Newcomers Club were picked for hairstyling demonstrations, at the club's recent Christmas luncheon at the Mayflower Hotel. Hair stylists from the House of Glamour and Mayflower

Beauty Salons, themselves wearing the new "halo" and "Oriental" styles, gave tips on the latest in make-up and hair styling techniques. (Crier photo by Robert Cameron.)

Choir sets St. John's concert

The choirs of Schoolcraft College will present a Winter Concert at 4 p.m. Sunday, Dec. 14, in the chapel of St. John's Seminary in Plymouth. Both the Chorale and the Symphonic Choir will perform under the direction of Marilyn Jones. They will be accompanied by Tamara Najar, their regular accompanist, and also by instrumental ensembles.

The Schoolcraft Chorale will present as its major work the 'Magnificat' by J.S. Bach. Student soloists Judy Wheeler, Jackie Kozyn, Sue Stott, Margaret Graham and Chris McAuliffe, along with alumnus Robb Morisi, will be featured in this work. Morisi will also perform the tenor solo in Respighi's 'Laud to the Nativity' the Symphonic Choir's offering of the afternoon.

Because of its unique monastic seating plan, the chapel of St. John's was selected for this joint concert by the Schoolcraft College day and evening school choirs. The organ will be played by seminarian Ed Perrone, with other instrumental

accompaniment provided primarily by Schoolcraft Music students.

The concert is free and the public is welcome. St. John's Seminary is on Five Mile near Sheldon in Plymouth Township.

Community obituaries Crawford

Mary E. Crawford, 60, of 11822 Priscilla, Plymouth Township, died Dec. 2 in St. Joseph Mercy Hospital, Ann Arbor. Services were held in Our Lady of Good Counsel Catholic Church following a rosary in Lambert Funeral Home. The Rev. Fr. Francis Byrne officiated. Burial was in Riverside Cemetery.

Mrs. Crawford is survived by her husband, Harry L. Jr.; her

mother, Mrs. Della Wescott of Hillsdale; a daughter, Mrs. Kathi Sells of Canton Township; a son, Dale L. of Ann Arbor; a sister, Mrs. Rita Holland of Hillsdale; a brother, Merrick of Hancock; and two grandchildren.

She was a housewife and a local resident for 22 years. She was also a member of Our Lady of Good Counsel Catholic Church.

Stewart

Violet T. Stewart, 47, of 41666 Ford Rd., Canton Township, died Dec. 5 in Detroit Osteopathic Hospital. Services were held in Schrader Funeral Home with The Rev. Jack T. Story officiating. Interment was in Woodmere Cemetery.

Mrs. Stewart is survived by her husband, William; a stepdaughter, Deborah Ford of Garden City and Cheryl Clemens of Northfield, Ohio; stepson, William; sisters, Ann Phillips of California, Margaret Hogan of Paradise, Calif.; and an aunt, Mrs. Jackie Hayes of Bay City. She had been an office worker at the Teamster Credit Union.

Gothard

George W. Gothard, 88, of 195 Burroughs, Plymouth, died Dec. 6 in Wayne County General Hospital. Services were held in Schrader Funeral Home with The Rev. William Stahl officiating. Interment was in Glen Eden Cemetery.

Mr. Gothard is survived by his daughters, Vira Anderson of Trenton and Vivian Anders of Perace, Ariz., sons, James of Plymouth, Carl of Pickens, S.C. and Harold of Spruce; 14 grandchildren and 13 great grandchildren.

He had been a carpenter before retiring.



Holiday Sale
Kimball
Swinger

ORGANS NOW ONLY \$1155

Reg. \$1555 Value You Save \$400

477-0771

ACT NOW LIMITED OFFER

- Complete with padded bench, music pack and delivery.
- Kimball 500 with the "Entertainer" — you play in minutes with just 2 fingers — without lessons!
- All the great rhythms! Waltz, foxtrot, rock 'n roll, bossa nova and more.

Holiday Spectacular

Full Kimball Artist Console Piano with a Lifetime Soundboard Warranty — complete with padded bench, first free tuning and delivery. **Reg. \$1595 NOW Value \$1195**

LaPRIMA music, inc.
"Everything In Music"

CHATHAM SQUARE Middlebelt at 11

See our fine selection of Holiday Gifts
Guitars, Drums, Musical Accessories
and many, many more

LIVONIA Garden City Southgate Pontiac
Woodward Center Ford Rd. at McCorbett Southgate Center American Village



ROSS B. NORTHROP & SON
FUNERAL DIRECTORS
Since 1910

18091 NORTHVILLE RD. NORTHVILLE 348-1233

22401 GRAND RIVER DETROIT - REDFORD 531-0537

LAMBERT
Funeral Home, Inc.

46401 Ann Arbor Road Plymouth 459 - 2250
1 mile west of Sheldon Road

Lambert a trusted name in Funeral Service for over 50 years

we invite you to inspect our facilities

Doc's Corner

by Dennis O'Connor

Pep band missing at games

Where are the pep bands at Salem and Canton home varsity basketball games?

Much of the excitement of the game and the enthusiasm of the crowd rests on music played during the contests — but so far this year, the band hasn't been on hand.

Already the teams are two weeks into their seasons, with three home games played, and not one person from the band had shown up with an instrument.

It only takes about 10 people to get together for two hours and play some music that adds immeasurably to the atmosphere in the gym and helps spur Plymouth teams to victory.

All schools the Chiefs and Rocks visit have pep bands at their home games, why can't Plymouth do the same?

The last two Plymouth home games featured an organ for music, but the atmosphere just wasn't the same. There is nothing better than hearing the trumpets, drums, etc. playing the two school fight songs and other pep selections.

Come on members of the Centennial Park band, get together, volunteer a little time, join that organ, and add to the excitement of our basketball games.



Two bylines you'll be seeing more of in The Crier Sports Section are Matt Norris and Joe Pierce.

Norris, a senior at Canton High School, reports Canton sports. He is a member of the school paper, working in the sports department, and played varsity football for the Chiefs last fall.

Pierce will be covering Salem sports. He is currently a junior at Salem, where he is a member of the sports department of WSDP-FM radio and colorman for Salem boys and girls basketball broadcasts.

Free throws cost Rock JV

The Salem junior varsity basketball team split a pair of decisions last week to move its record to 2-1 for the year.

After winning an easy 65-48 contest over Livonia Franklin on Tuesday, the Rocks, unblemished record was blistered at the buzzer against Redford Union on Friday, 54-52.

The RU Panthers outscored the Plymouth 16-5 in the third quarter, and the Rocks helped things out by converting only four of 13 from the foul line.

Sophomore forward John Broderick led the Rocks with 18 points, followed by Dan Brightbill with 10 and freshman Rich Hewlett with nine.

Plymouth led 18-17 and then 36-30 after the first two periods of play, before that third period disaster.

The significance of the Rocks' poor free throw shooting was

glaring, when statistics showed they actually made three more field goals than the Panthers.

Coach Craig Bell cleared his 16-man bench in the Franklin contest, as all members played more than half a quarter.

An 18-8 second quarter margin gave the Rocks a 31-20 lead at halftime, and they complimented those efforts with a 19-9 third period to turn the game into a runaway.

Balanced scoring saw Brightbill take honors with 12, followed by Hewlett and freshmen Mitch Haas with nine a piece.

But once again the Rocks had trouble at the line, converting only six of 20 charity tosses.

"The Franklin coach said his team quit — I think we out-conditioned them," said Bell after the game.

Salem gals head All Sub-8

Suburban Eight All-League girls basketball selections were announced last week, with the champion Salem Rocks placing two members on the first team.

Junior Peggy Moore and sophomore Kathy Dillon were two of the first five girls chosen.

Members of the all-conference third team included sophomore Carol Crissey and freshman Diane Goodrich.

Two other players received honorable mention awards' senior center Linda Agardy and senior reserve Dorothy Spitz.

Salem finished the conference season with a perfect 10-0 record, two games ahead of its closest foes.

Salem breaks two records

Cont. from Page 21

Brian Wolcott added 14 points while Mike Primeau chipped in with 11. Thoman cleared his bench in the fourth quarter, as all but two Rocks scored.

The most impressive aspect of Plymouth's victory was the continual team play on offense, which led to the Rocks scoring more than 20 points each quarter.

Of 42 field goals, 30 came with assists choosing the effectiveness of the Plymouth passing game. But more important, six different players accounted for three or more assists each.

A Wolcott jump shot with 5:54 remaining in the first period gave Plymouth a 5-4 lead, an edge the Rocks never lost.

With the score 15-12, Ellinghausen pumped in eight points and his brother, Tom, tossed a free throw to build a 24-12 margin after the first period.

That lead increased to 47-29 at the half and 69-46 after three periods.

Franklin was out of the game after those first five minutes

The only thing that kept the Livonia team within 30 points of the Rocks was its near-flawless free throw shooting 17 for 17 in the first half and 22 of 23 after three quarters.

Forward Primeau was an important factor under the boards for Plymouth, and the play of guard Mark Gothard was a key to the success of the Rocks passing game.

The Rocks take their 1-0 Sub-8 record into action Friday night when they play a strong Trenton team at home. Trenton is coming off an impressive 65-56 win over Belleville.

"It's going to be a physical game," Thomann said. "Trenton is an extremely aggressive team, and we have to play physically under the boards to win."

Canton falls, 47-40

Cont. from Page 21

unanswered points to undo Canton.

Farmington held a 37-30 lead after that quarter, maintaining the margin through the final eight minutes of play.

Canton never came closer than seven points in the fourth quarter, and was down by as many as 10 early in the period.

Tom Close led the Chief scorers with 12 points, followed by Keith Osborne and Rob Mandle with eight apiece.

Canton totaled a massive 31 turnovers, in the game, and finished with a lowly shooting percentage 32% (18 of 56).

"We're getting a lot of rebounding, but we're not scoring points," said Cavell.

"If we did what we were supposed to do there would be no problem," he said. "But again we're going to get better — we've got to get better, because we're better than we played, tonight."

Chiefs edged at buzzer, 55-54

The Canton junior varsity basketball team lost a heartbreaker at the buzzer when the team's leading scorer, Randy Rienas, failed to connect on a 17-footer to give Farmington a 55-54 victory last Friday night before the varsity contest.

Canton's record stands at 1-1 for the season.

With the score even, 12-12, after the first eight minutes of play, Farmington built a small lead in the second quarter thanks to sharp outside shooting that foiled the Chiefs' zone defense.

The Falcons went into the locker room with a 31-25 halftime lead, and maintained it midway through the third period.

With three minutes left in that quarter and the score 37-33 in favor of Farmington, Canton switched to full-court pressure and a sticky man-to-man defense that sparked a comeback. The Chiefs reeled off five straight points and grabbed a 38-37 lead.

The rest of that quarter saw sawed back and forth, with the Falcons taking a 41-41 margin into the final stanza.

The Chiefs mounted a quick three-point lead with two opening buckets, but Farmington came right back and held a five-point advantage going into the final two minutes of play.

With the score 55-50, Chief guard Brent Eckels hit two buckets to cut the lead to one with only 30 seconds remaining. Forward Keith Fuelling then stole the ball on the in-bounds pass and threw to Rienas, whose shot went off the rim.

Two crucial traveling calls on would-be Canton layups in the last minute of action added to the Chiefs' frustration.

Rienas pumped in 19 to go along with his 11 rebounds. Fuelling added 13, while freshman guard Butch King chipped in 12.

Canton shot 52% from the floor (22 of 42) but didn't get many shots at the basket, failing to penetrate the Farmington defense.

The

Lent's

MAN KNOWS...



that the

Hathaway shirt

is a cut above

Christmas Hours: Mon. - Sat. 9:30 - 9

Sun. 12 - 5 p.m.

Open Sunday after Christmas for exchanges

Free Gift Boxing

Lent's Charge Master Charge Bank Americard

LENT'S

CUSTOM CLOTHING

aboard the Mayflower
downtown Plymouth
453 - 0790

Schools to ask university assess modular scheduling

Cont. from Page 3

board his group expected a response soon.

"This (the board's decision) is putting us off until April," he said. "Basically, there is a tremendous amount of dissatisfaction with the current structure -- it's the atmosphere of the school under modular scheduling.

"We ask for an answer: either abolish modular scheduling or give us a chance to send our students to a school with a traditional system -- they (the two systems) can't work in the same building. We would like a definite answer."

Merchant said the results of a survey his group conducted earlier this fall showed that more than 2,200 parents of the 3,708 who responded were unhappy with modular scheduling.

"You've told us it's your way or nothing," said Mirto. "If you're asking the board to take action on the basis of this survey, you're asking us to be prima facie negligent."

Board Vice-President Marcia Borowski defended the board's decision to seek an intensive study of scheduling and programming at Centennial Educational Park.

"Before we take a major step in altering a major program or continuing on our present course, we need some solid information," she said. "We do want an objective outside evaluation. We have long felt we have not had information we needed about the park."

Board member Joe Gray urged the group to take a part in studies of the scheduling. "I have swung back and forth from traditional to modular to semi-modular....You'll be able to put more input into this than any group has before."

In a related move earlier in the evening, Florence Beier, the district's administrative assistant for community relations, presented the board with a tentative structure for the massive new Citizens Advisory Committee approved by the board last month.

The 144-member body would include 12 subcommittees, each with 12 members.

Singles out for discussion Monday was the proposed scheduling subcommittee, which would address itself to modular scheduling at the high schools.

As proposed, the subcommittee would include three parents and one student named by the administration,

Pathfinders plan benefit

The Plymouth Seventh Day adventist Pathfinder Club will present an evening of fun and music at Salem High School Saturday, Dec. 13, for the benefit of the Plymouth State Home and the Pathfinders.

Featured in the evening's performance will be clowns, and a magic show.

Donations for the program are \$1 in advance or \$1.25 at the door. The performance will begin at 7 p.m.

Tickets may be purchased in advance by calling Steven Baggett at 349-8795.

one 1975 graduate, three parents selected at large and three parents and one student representing the Concerned Parents.

Merchant condemned the subcommittee's proposed makeup, insisting that the Concerned Parents were poorly represented. "Personally, I find this totally unsatisfactory and unacceptable," he said. He added that when the new scheduling was begun four years ago, it was labeled an experiment.

Tax request hit

State Sen. Carl Pursell (R-Plymouth) has gone on record opposed to a proposal to triple the Detroit income tax on commuters. "This proposal must not, and in my opinion, will not, pass the Legislature," he said.

"The State has equally serious financial problems. I think Detroit must meet its very real problems the same way we are - by living within its means and utilizing internal revenue sources. Under no condition must suburban taxpayers be forced to contribute more toward the operation of Detroit city government," Pursell said. "I will expend every personal effort to prevent it."

"We've had four years of experiments," he said. "We've got polarization in this area."

Borowski challenged his contention that Concerned Parents was badly represented on the proposed scheduling subcommittee.

"I'm wondering if you don't have too much representation," she said.

Said Board Treasurer Tom Yack, "I hope the committee is not formed in an adversary relationship."



our 20th year of service

ROBERT H. JOHNSTON AGENCY

GENERAL INSURANCE
747 SOUTH MAIN ST.
PLYMOUTH
453-3193

Wm. Fehlig
Real Estate

BUILDING SITES - two 2 1/2 acre sites on Beck Rd. just south on North Territorial. Call for details.

BRAND NEW RANCH IN Northville Twp. with 3 ACRES. Horses are permitted. Three bedrooms, 2 full baths, including master, dining room, family room, kitchen has dinette, fireplace, screened porch, basement, and attached 2 plus car garage. Offered at \$69,900. You must see this one!

453-7800
906 S. Main St.



IMMEDIATE POSSESSION
3 bedroom frame, older home, new wiring, plumbing and furnace. Basement and garage, good intown location only \$27,900 will consider land contract terms.

PHONE FOR AN APPOINTMENT
453-7793



TOM NOTEDAERT REAL ESTATE
1285 S. MAIN ST. PLYMOUTH

McKEON, INC.
REAL ESTATE

Featured Home of the Week



IMMEDIATE OCCUPANCY BUILDER'S MODEL
MANY EXTRAS \$38,900.

453-6800

WANTED:
Your
JUNK CARS
Or
TRUCKS
PA 1-1444 Rea Auto Parts



GARLING REALTY
199 N. MAIN
PLYMOUTH

CUSTOM 3 BEDROOM
Brick Ranch in Plymouth Twp. on 1/2 acre, 2 1/2 car attached garage, 2 full baths, finished basement, formal dining room. \$64,500

BRAND NEW 3 Bedroom
Ranch going up. Ready in 60 days, carpet thru-out, large rooms. Only \$27,900.

453-4800



J. L. Hudson
REAL ESTATE CO.

CHRISTMAS SURPRISE
Give your family the finest Christmas. This beautiful 4 bedroom colonial with family room and fireplace, wet bar. A great entertainment center. Also features 2 1/2 baths, one off master bedroom with walkin closet, basement, 1st floor utility room, large attached garage. Corner lot. Beautifully landscaped. Assumption available. Price at only **\$57,500**

PREMIUM QUALITY
At a bargain price is this 3 bedroom brick ranch with finished basement. Large living room, kitchen and bath. Located in Northville. Assumption available. Immediate occupancy. Let us help you with your bargain hunting. Call today. Fabulous bargain at **\$37,500**

HOW MANY ACRES
Would you like? We have a fine 8.7 acre parcel. Located in Superior Twp. Great place for that home you've always wanted to build. Also good investment potential. Fine assumption available. Land contract negotiable. **\$34,900**

LAND AND BUILDING
Just offered is this fine 5 acre parcel with 60 x 30 building with 12 ft. and 10 ft. doors. Oil furnace. Located on a corner plot in Superior Twp. Land contract terms available. A whale of an investment for only **\$65,000**



607 S. MAIN ST.
PLYMOUTH
453-2210

Crier classifieds **CALL 453-6900**

DEADLINE: 5 p.m. MONDAY

ARTICLES FOR SALE

Minnesota Fats - 8' pool table with slate top w/ accessories - \$125. 455-1543.

BSR Airline stereo - like new - \$35. 453-8239

Wet suit, air tank, regulator and more. All Good condition. For Sale to experienced skin diver only! 455-5147.

9 boxes smoked gold vein mirror tile. \$4 a box. 455-9043.

Riding Horse for Sale. 8 year old white gelding. Call 459-3962.

21" Sears TV. 2 mo. old. Portable Hoover clothes washer. 453-1114.

Propane Heater and two no. 20 gas tanks. Ideal for small camper. 453-6902 before 5 p.m. ask for Bob.

1/2" Heavy duty, industrial hand drill, 550 RPM, Miller Falls, \$35. 453-4314.

ARTICLES FOR SALE

Encyclopedia set. Excellent condition. Like new. All year-books to 1974. \$350 value for \$75. Great Christmas gift. 453-6565.

Get your MOOD Rings, PUKA beads, squash blossoms and other quality jewelry at low prices - Hidden Treasures Thrift Shop - 849 Penniman - across from the Plymouth Post Office.

SERVICES

Private guitar lessons - given in my home - 2nd thru 10 grade only - \$2.50 1/2 hr. Call Donna - 453-8631.

Bob Vollmer Janitorial Service. Clean up for the Holidays. 459-0134.

Professional Schnauzer & Poodle grooming in my home - \$5.00 Plymouth area - 459-1241.

HELP WANTED

Concession & Pro Shop help. Apply 8 a.m. to 5 p.m. at City of Plymouth Cultural Center - 525 Farmer St.

Parents don't let your budget fence you in. Earn extra money part time - Work close to home Call for interview - 459-9860.

HOUSE FOR SALE

Ply. 3 Bd'rm. 1 1/2 bath colonial, kitchen overlooks sunken family room - brick wall fireplace - \$47,900 - assumption - 455-2318

LOT FOR SALE

City of Plymouth - small light industrial lot, sewer & water, Latture Real Estate - 453-5158.

VEHICLES FOR SALE

1972 Volkswagon auto stick, radio, rear window defroster, good condition. \$1275. 455-9382.

'74 R.D. 350 Yamaha. Exc. cond. \$800 455-0876.

Fiat 1973 124 Sport coupe 26-34 mpg like new throughout will take any reasonable offer must sell quick! Call evenings or all day Sunday 453-6762.

1970 Maverick 6 cyl auto. \$650 or Best Offer. 459-1794.

CRUIER CURIOSITIES

Congratulations to the Plymouth Goodfellows for their work last Saturday. Best wishes to the Canton Goodfellows this coming weekend. The Crier staff is pleased to have been able to help such a worthy cause. Donations may be made to the two groups through the City of Plymouth and Canton Township halls respectively.

Tucker eats tapioca pudding.

CRUIER CURIOSITIES

Mr. and Mrs. KRS: Happy reading, Merry Christmas from KRS.

George, Mac, Frampton is returning to Plymouth Salem H.S. on January 18th. Mary.

Good Luck on exams, Jen.

CRUIER CURIOSITIES

Ask Hank Berghoff about his sleeping bag zipper. It sticks.

There are only 12 shopping days left before Christmas - in case you too haven't even started shopping.

Tucker would eat ANYTHING

Place Your Want Ads with
The Plymouth
Community Crier
10 Words \$2.50
10¢ for Each Additional Word

10	20	30	40	50
\$2.50	\$5.00	\$7.50	\$10.00	\$12.50
\$3.00	\$6.00	\$9.00	\$12.00	\$15.00
\$3.50	\$7.00	\$10.50	\$14.00	\$17.50

Call 453-6900



BI-CENTENNIAL bumper stickers and window decals are available at the Passage - Gayde American Legion Post, 888 Sheldon Rd., and at The Community Crier office, 895 Ann Arbor Trail for \$1 each.

WANTED: NEWSPAPER CARRIERS



HOUSEHOLD SERVICES

DAVE'S 459-3090
CARPET CLEANING
CARPET SALES & INSTALLATIONS

J.L. HUFFMAN
Roofing, Siding,
Trim & Gutters
I work year 'round
455-5409

D.A.C. CONSTRUCTION CO.
Home improvement, rec rooms,
roofs, additions, concrete, gar-
ages, etc.
FIREWOOD
453-6537 or 455-4251 evenings

ELECTRIC WIRING AND REPAIRS
*fuse boxes *meters
*plugs *switches
Violations Corrected
455-1166

CARPET CLEANING WITH EXTRACTION \$19.95
Any size living room & hall
DOBOS MAINTENANCE
561-1548

CARPET INSTALLATION
All Methods Available
Relays, Repairs, Restretches
Reasonable Rates
455-5519

H.F. STEVENS
ASPHALT PAVING
Residential Work
Repairs, Seal coating.
Licensed & Insured
453-2965

TRADESMEN SELL YOUR SERVICES HERE FOR AS LOW AS \$4.25

WESTERN SHIRTS

**GUYS or GALS
A GREAT GIFT**

Corduroy, Two Tone,
Flannel, Embroidery.
LEVI - LEE &
KENNINGTONS of CALIF.

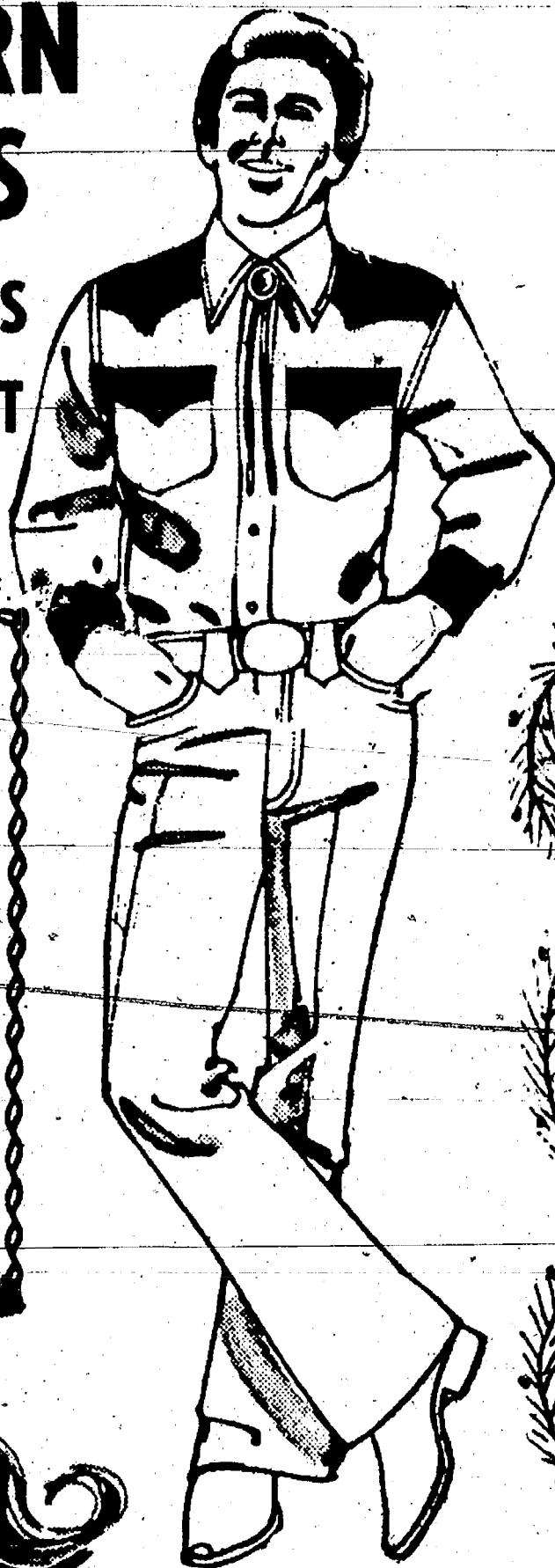

**MEN'S
DRESS
SLACKS**

SELECTED STYLES
**20%
OFF**

GOOD TO DEC. 25th

GIFT IDEAS

EMBROIDERED BLUE DENIM SHIRT JACKETS \$25



**MINNETONKA
MOCCASINS**

**HANDMADE
AMERICAN
INDIAN
JEWELRY**

**FRYE & DINGO
BOOTS**

**BELTS
&
BUCKLES**

HIS & HER by Lee



**GREAT
WESTERN
STYLE**

¾ length coat of Gengvard treated Sylka Suede Leather. Shepard's Kurl lining and Kurl feathered seams.

\$87.50



\$5.95

**COPPER
JEWELRY**

**WALLETS
&
GLOVES**

**LEVI'S
HEAVY WEIGHTS
&
WASHED DENIM**



GET *Comfy*

in a Comfy goosedown insulated jacket. Light weight and super warm.

\$80



COMPLETELY WASHABLE SEPARATES

SLACKS: \$14 and up
JACKETS: \$22 & up

Hopsack &
Double Knits
GREAT COLORS

"YOU DON'T HAVE TO RIDE A HORSE TO SHOP AT"

EMERSON'S

485-1800
522-1313

217 North Main Street Plymouth
Holiday Hours: Mon. - Sat. 9:30 - 9; Sun. 1-5