



**STARKWEATHER WAS 50-YEARS OLD** last Sunday and a crowd of students, ex-students, teachers, ex-teachers, and civic leaders turned out for the school's re-dedication and the open house. (Crier photo by Susan Sheiner).

## Schools will hold bond vote in fall

A special school election will be held at an as-yet-unspecified date this fall for a building bond issue. In a resolution passed by the Plymouth-Canton School Board Monday, a fall election was unanimously approved for a bond issue "based on a comprehensive plan for full utilization and renovation of present facilities" and which would also finance "new buildings to provide for growth in student population."

Further details on the special bond election will come after research is conducted into why the proposed \$29.750 million bond issue was defeated April 23, say school officials.

# Twp. seeks Sept. 13 charter referendum

BY DONNA LOMAS  
 The Plymouth Township Board of Trustees voted unanimously last night to put the question of a charter township status before a vote of the people in a special election this fall. A date of Sept. 13 will be sought by the township, but county approval is necessary before a date can be officially set.

Trustee Maurice Breen moved to reconsider a previous action the board had taken which would have automatically made the township a charter township, if no referendum petitions were filed in 60 days. "I am reluctant to make this motion," said Breen, "in light

of the fact that a study has been done, a public hearing has been held - we had ample opportunity to talk about it. I don't remember anyone saying they objected to becoming a charter township except in the area of taxation.

"However," he continued, "my paramount interest is to render the best possible form of government to serve the needs of the populace."

The request to reconsider the earlier motion was made by a Township Charter Study committee member.

It will cost the township between \$3,000 to \$5,000 to hold a special election.

"I think that we could have

spent the money in a better way," said Supervisor Tom Nobeartaert, unless the voters want it otherwise."

"We had no conspiratorial notion in mind, (by not deciding to hold an election on the township status)," said Trustee Richard Gornick. "We had no board project waiting in the wings. It does not bother me at all to spend the money to hold the election, if this is what the community wants."

Clerk Helen Richardson also called for information on what a charter township is to be publicized and made available to the public before the election was to be held.

## State: Greenstein misspent

BY CHAS. CHILD  
 A state audit of Canton Township's records says that former Supervisor Robert Greenstein's administration altered the township's pension plan to their benefit and illegally allocated money on township projects, without approval from the Board of Trustees.

The report is dated March 15, but was not released to the press by Supervisor Harold Stein until last week.

It was referred to the state attorney general's office for possible criminal prosecution. John Wilson, the attorney to whom it was referred, declined to comment on the case.

State Police investigators are still looking into other alleged misconduct by former township officials but the report gave no indication when their findings would be released.

Auditors from the Michigan Department of Treasury said Greenstein authorized two expenditures - refurbishing the senior citizens hall, and remodeling the townships offices and fire hall - without approval from the Board of Trustees.

An expenditure without board approval violates the 1970 compiled laws of the state, the report says.

Mike Gorman, deputy treasurer of Canton, said spending money first and then adjusting the budget later is common practice among local governments in this area.

He said the auditors found merely "technical" violations of the law. "I don't believe anybody has ever been prosecuted

on these charges," he said. "There were also no specific bidding procedures in effect in Canton at that time." Gorman said, "so Greenstein really did what all Supervisors had done up to then."

Specific bidding procedures  
 Cont. on Pg. 11

## Youth faces rabies shots; dog sought

A five year old Plymouth Township boy who was bitten by a stray dog Sunday afternoon is undergoing painful rabies shots for two weeks or until the dog can be found, Wayne County Sheriffs report.

Wayne County Sheriffs are looking for a black poodle dog, with a poodle-type haircut, one-foot tall who fit young Walter Baughman in his township front yard Sunday.

Baughman, who lives at 9402 Lilley with his parents, was bitten at 3 p.m. Sunday afternoon on the right index finger.

After his parents, police and neighbors could not locate the dog, he was taken to Henry Ford Hospital Monday afternoon to begin the rabies treatment. The shots must continue for two weeks unless the stray dog can be found.

Walter's parents and the Wayne County Sheriff are saying that anyone who has seen a dog fitting the 'poodle' description to contact the Wayne County Sheriff's Department at 721-2222 immediately.

**MOURNERS ESCAPED INJURY**, when a car in a funeral procession, (foreground) was going through a red light last Thursday according to the Wayne Co. Sheriff. The vehicle was struck by another car, (background) at the intersection of Ford and Canton Center Rds. Five persons in the car that had a green light were all residents of Detroit and were taken to Wayne County General Hospital and released without being treated. (Crier photo by Chas. Child)



# Report urges planned growth in Canton

BY CHAS. CHILD

A report strongly recommending that growth in Canton be controlled and planned was presented to the Canton Board of Trustees last night.

Prepared by the Growth Management Study Committee, the report said planning is necessary to maintain the general quality of life in Canton, to prevent severe crowding in the

schools, to keep taxes at a reasonable rate and to prevent overtaxing of services, especially sewers.

The lack of present and planned sewer capacity was listed as the "prime basis for a growth control ordinance in Canton."

The report made eight specific recommendations. The Committee said it chose the latter of the following three attitudes

toward growth, it said was present in Canton today:

1. Continued population growth was either inevitable, or fundamentally good, or both.
2. All growth should be stopped, and
3. Growth is a variable to be influenced in pursuit of a desirable quality of life.

The committee said it was not their "intent to set any ceiling

figure in terms of population" for the township. They were interested in arriving at a population figure that would "optimize the quality of life."

Future growth was inevitable, the committee said. It said people are moving to Canton for the following reasons: 1) to escape from the inner city, 2) an attractive school system, 3) a good location for rapid transit

to the inner city, 4) lower new housing costs over areas that aren't cleared and flat and, 5) the desire of many to live in a rural area within reach of metropolitan activities.

The main problems of growth in Canton is that the population outstrips the services available, especially since the township was previously rural, the report said.

The committee is afraid the taxes will go so high to provide the necessary services that people will leave, "heightening the burden on those remaining. A planned and orderly growth rate can markedly decrease this type risk."

The committee also said that limited sewer capacity provides the main roadblock to further growth and the most urgent reason to plan it.

"The quality of life for the 'aggregate' (total) citizen has deteriorated, and that it may continue to deteriorate until a growth policy is designed, adopted and implemented," the report concludes.

## Gate crasher on wrong track

City of Plymouth police report that a Lincoln Park man escaped injury after his car was struck by a C&O train last Tuesday.

Plymouth Police reported that Gary Palgut, 25, of 357 Emmons, Lincoln Park, was east-bound on Ann Arbor Trail when he attempted to drive around the crossing gates and was struck by a C&O train at 11:04 p.m. Tuesday.

## List of Growth Committee's proposals

Recommendations are listed in order of the number of members who supported them. The numbers in parentheses represent the number supporting use of each specific technique first and the number not supporting use of each technique second. Recommendation 1. Canton Township should increase its minimum lot size significantly in future platings. (14-0)

Since numerous subdivisions and plattings of new subdivisions with 60' minimum frontage and numerous multiples already exist, we feel a larger minimum lot similar to such surrounding communities as Northville Township and Novi, would not be exclusionary. Further, we feel it could aid this community in terms of decreasing density, and therefore, consumption of services available.

Recom. No. 2 Strong application of zoning and other existing development regulating techniques be used in Canton. (13-1)

Included in this is strict adherence to the master plan. Although we also support the strict application of building codes, we feel this support is out of concern for the homeowners, and not a true growth control technique. In addition, we assume strict application of codes should already be the practice. Hence, although there is strong support for this, it is not considered a substitute for a stated, visible growth control policy. This committee would hope to see an adopted policy representing a visible commitment to growth management on the part of the township.

Recom. No. 3 Moratoriums of varying durations on certain kinds of development should be used in Canton Township. (12-2)

We feel Canton should be able to institute a moratorium on new plattings until ordinances are adopted to support a master plan. We feel Canton could possibly institute a moratorium on building permits to maintain the status quo while further study, design, and implementation of a growth management plan for Canton is completed. In light of our present limited sewer capacity, we feel there would be grounds for a sewer moratorium.

Cont. on Pg. 25

**YOU ARE INVITED TO A  
POP & PIZZA PARTY  
for  
JACK BOLOGNA  
Tuesday, May 17, 1977  
PLYMOUTH CULTURAL CENTER**

525 Farmer Street

6:00 P.M. To 9:30 P.M. \$2.50 Per Person

Paid for by the Committee to Elect Jack Bologna  
Schoolcraft College Trustee, Geo. Lawton, Treas.

**LEWIS POOL CENTER**  
28302 JOY RD. Phone 261-0721

**A POOL FOR EVERY YARD!!**

**24' Round \$893<sup>00</sup>** INCLUDES

**AECEAN**

**MAINTENANCE FREE ALUMINUM**  
35 lbs Chlorine or the Winter Cover

**Solar Blankets**  
Made by LEWIS  
Heat Your Pool  
10° - 15° Over Air  
Temperatures.

**REPLACEMENT EQUIPMENT**  
1-Pump & Motor  
2-Filters Sand or D.E.  
3-Heaters  
4-Chemicals  
5-Covers

**Solar Blankets for any Size Pool**  
We build the vinyl liner for every pool we sell, its expandable to a 6' depth, and, our warranty is 15 years

**LEWIS POOLS** **LEWIS POOLS** **LEWIS POOLS** **LEWIS**

**OPEN 7 DAYS A WEEK**  
HOURS:  
MON-FRI 10-8  
Sat & Sun 10-5

**Why is Lewis Pool in Business 14 years?**

**SAVE \$500<sup>00</sup>**

Expandable liner to 6' depth, 15 yr. warranty on liner. 35 lbs chlorine or Winter Cover.

**HUGE 6'x19' PATIO, ALL EXTRUDED ALUMINUM, DECK PRE-ASSEMBLED, WITH SAFETY LADDER AND IN-POOL LADDER. MAINTENANCE FREE ALUMINUM... INSTALLATION AVAILABLE**

**Famous LEWIS-CHECKLIST:**

1. Heavy gauge liner
2. 15 year warranty on liner
3. Thru-wall skimmer
4. 6 inch top rail
5. 6 inch upright
6. 3/4 hp motor & pump
7. Sand filter
8. Aluminum ladder
9. Vacuum
10. Vacuum hose
11. 16 foot telescopic pole
12. Test kit
13. Starter chemicals
14. Complete instructions.
15. Free delivery
16. Deposits accepted
17. 90 days same as cash
18. Financing available
19. 35 lbs. of chlorine or a Winter Cover

**COMPARE!**

**POOL WITH LINER ONLY:**

18' Rnd.....	\$392 <sup>00</sup>
21' Rnd.....	\$470 <sup>00</sup>
24' Rnd.....	\$531 <sup>00</sup>
27' Rnd.....	\$654 <sup>00</sup>
15'x24' Oval...	\$683 <sup>00</sup>
15'x30' Oval...	\$815 <sup>00</sup>
18'x33' Oval...	\$967 <sup>00</sup>

15 YR. WARRANTY ON LINER

35 lbs. Chlorine or Winter Cover

**Replacement liners available for any pool**

35 lb, 75 lb, 100 lb, & SOCKIT for your pool opening!

**hth** **hth** **hth**

35 lb, 75 lb, 100 lbs, & SOCKIT for your pool opening!



# Moderate security prison set for N'ville Twp.



COME INTO MY HOUSE LITTLE GIRL, says the witch in Starkweather's production of Hansel and Gretel last Friday. From left, Vince Seltzer (Father), Kathy Risbridger (Mother) Lisa Madis (Witch), Orly Borowski (Gretel) and Chris Harvey (Hansel). (Crier photo by Chas. Child).

## Sports duplication discussed

BY DONNA LOMAS

A proposal to eliminate seventh and eighth grade sports in the schools because of duplication with a community athletic association was discussed at Monday night's school board meeting.

Jim Sinclair, President of the Plymouth Canton Junior Athletic Association, spoke during the Citizens's Suggestions part of Monday's meeting.

He said the PCJAA favored eliminating the middle school sports of basketball (boys and girls) and football because it would save the school district \$16,000 (the bulk of which goes for coaches salaries), thereby giving the districts more money to implement girls sports. Other financial costs to the schools involves transportation, insurance and equipment.

Sinclair pointed out that in the PCJAA, player and parent

participation is increased - every player is guaranteed to play. In school sports, not every player on the team always plays. Sinclair also mentioned the problem young students have when they have to choose between school and community sports.

Trustee E. J. McClendon said that school sports fulfills a different role than a community-organized sport does.

"I am extremely grateful for the PCJAA and their hard work," McClendon said. "But as a school district, we're obligated to meet certain standards and programs. Athletics are used as a single experience in involving students and indentifying with that school."

In a report delivered by Athletic Director John Sandmann later in the meeting, Sandmann reported that all existing programs on both the high school

and middle school levels, be continued.

In one recommendation, Sandmann specifically recommended that all existing middle school athletics be maintained, but with additional emphasis to accommodate increased interest in participation.

"We asked everyone about the middle school athletics," he said. "They all said to continue. The only people we didn't ask in fact, we the students. So I sent out questionnaires to the three middle schools; two have responded so far. Their response is overwhelmingly in favor of

Cont. on pg. 17

BY W. EDWARD WENDOVER

A "moderate security" prison will apparently be built on Sheldon Road in Northville Township if the State of Michigan gets its way.

In a letter sent to the Wayne County Board of Commissioners Monday, the state's budget director, Gerald Miller, said the state is formally asking for an option on the Wayne County Boys Training School property to construct a prison there.

The state asked the county to submit a resolution to Lansing by May 27 authorizing sale of the training school property to the state in two parcels.

Unused for several years, the county property is split into two parcels, one with 121 acres located on both the east and west sides of Sheldon and one with 607 acres on the west side of Sheldon.

The first parcel, which contains all of the abandoned buildings and the mechanical plant which formerly housed the training school, is valued at \$6 million. The state is asking for a 120-day option on that property.

The second parcel, which contains only a few farm buildings, is valued at \$3 million by the state. The state has asked for an agreement which would allow them to exercise an option on the second parcel any time before Oct. 10.

Wayne County Commissioner Royce Smith, whose district includes the Plymouth-Canton Community, has opposed the location of a prison on the site and said the state's request to split the parcels could mean that more than one correctional facility would be built there.

The state's latest letter has touched off a flurry of activity at the county. In response to the state's offer to purchase the county attorney, the county bureau of taxation and the

county public works committee are studying the matter.

A public hearing is expected to be called on the issue to give local residents an opportunity to vent their feelings on the project. Many local public officials have opposed the location of a prison on the site.

Opponents to the prison have said that there is too great a danger of escapes (such as the Detroit House of Correction already has) and that local tax revenues would be threaten threatened by the state ownership of the land.

Miller's letter to the county said that no restraints on usage of the property could be established by the county if the property is to be purchased by the state.

He said that the state's offer to buy the land was conditioned upon the state Tax commission's approval, the legislature's appropriating the money and approval by the state administrative board and the attorney general.

Northville Township currently has about one third of its land used by non-taxpaying institutions like the Detroit House of Correction, the Plymouth Center for Human Development, Northville State Hospital and Hawthorne Center.

## Canton adds 10 cops

Ten new policeman were added to the Canton Police Department by a 6-1 vote of the Board of Trustees last Tuesday. The Board also appropriated \$3,000 for their uniforms. Trustee, Anne Bradley voted no.

The Board stated that the ten must pass the Schoolcraft College training courses and a physical exam, and sign a statement that they would live in Canton.

## Jaycees

## Pass

## Sand

SAND AND SWIM is the new theme for the Plymouth Jaycees annual sandbox fill project - the service group will this year be selling swimming pools as well as the traditional sandbox sand. Saturday, May 21 (and Sunday, if necessary), the Jaycees will be delivering their kiddie-pleasing goodies. Sand goes for \$1.25 per garden wheelbarrow and the backyard pool - complete with a seesaw - goes for \$15. To order sand or a pool, call project chairman Harold Matthews (that's him on the swing) at 453-8112. Also playing around in the picture are: (in foreground) Heather Mirto and Nancy Petrocelli, splashing in the pool behind them is Jaycee Wendell Sykes, and pushing Harold on the swing is Ron Myers. (Crier photo by W. Edward Wendover.)

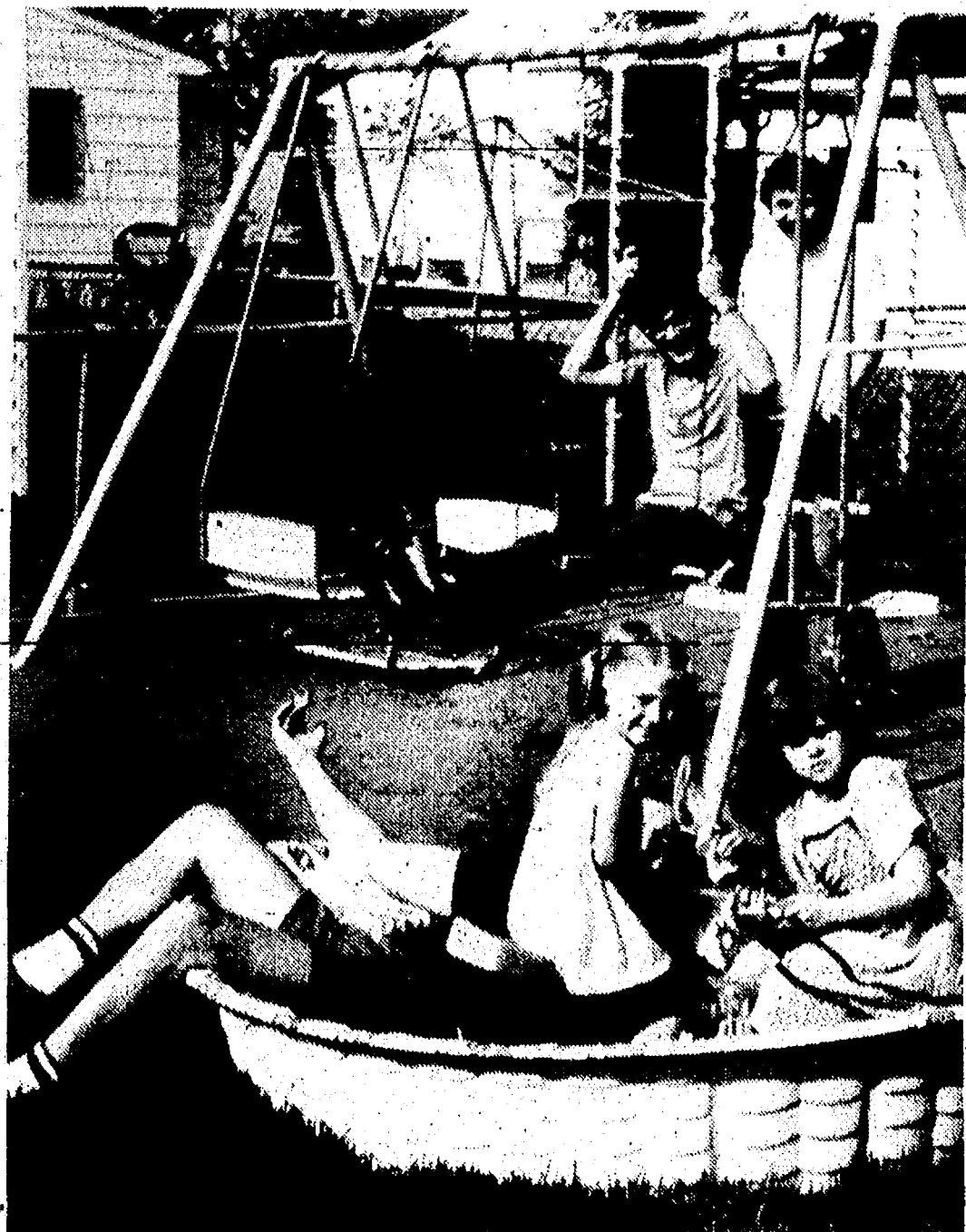

## Comm. to discuss 45-15

The Plymouth Canton School Board and the Calendar Committee will hold a public hearing Monday, May 16, at the Canton Cafetorium at 7:30 p.m.

The hearing will review the boards' recommendations from the schools and suggestions and research done by the Calendar Committee.

On May 23, at the regularly scheduled board meeting, the school board is expected to adopt one of the suggested 45-15 calendars.

## Fire truck mired in mud

If you've got to get stuck in the mud, try to find a less embarrassing spot than that picked by the Canton Fire Dept. last Wednesday.

A Canton fire truck, responding to a truck fire which was reported to be on southbound I-275, found the truck to be on the northbound lane and used a service drive on the new expressway to shift directions. But, according to Canton Fire

Chief Mel Paulun, the service drive gave way and the truck became mired.

It took almost two hours to get a wrecker in and the truck on its way, meanwhile, all the passersby on the expressway saw the firetruck's plight.

And to add insult to injury, Paulun groaned, the truck fire was already out by the time firemen were on the scene.

# Legion honors citizens, students

Outstanding citizens and students will be honored this Saturday by the American Legion at their Tenth Annual "Recognition Night" (Law and Order). The event will be hosted by the Passage Gayde Post and Auxiliary No. 391, this Saturday evening, May 14. A buffet supper will be served at 6:30 p.m. for the honorees. Awards will be presented in the categories of "Policemen, Firemen (both the City of Plymouth and Plymouth Township) and Industrialist and Businessman of the Year. Students from Salem

and Canton will be recognized and one will be honored as 'Student of the Year.' A "Citizen of the Year" award will be made to a Plymouth Community resident for outstanding service to the local area. Addressing the gathering will be Roy Smith, 52nd District - Representative. Newly-elected 14th District Senator Robert Geake will also attend, and tentatively, Congressman Carl Pursell. The general public is welcome to attend the program at 7:30.

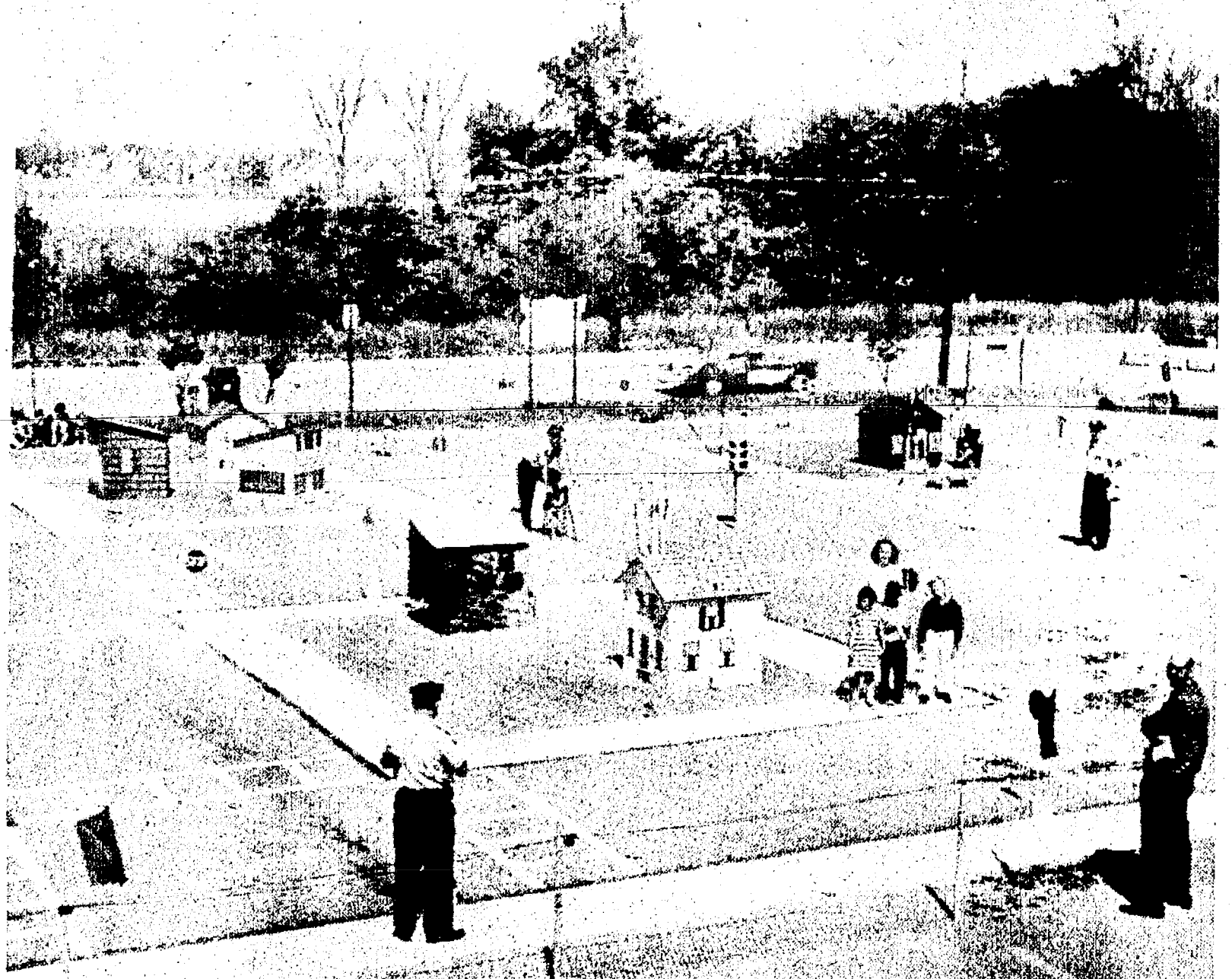

**WAGENSCHUTZ** CALL FOR FREE ESTIMATE  
**LAWN SPRAYING**

"25 Years Experience"

- \*Liquid Fertilizer \*Insect Control
- \*Weed Control
- \*Crab Grass Control \*Fungus Control

Call **GL 3-1576**  
or Call Plym 453-2360  
P.O. Box 325—Plymouth, Mich.  
**SERVING CANTON & PLYMOUTH**

**BIKE SAFETY CLINIC**  
**For Kids in Grades K-8**  
**SUPER DRAWING!**

PRIZES WILL INCLUDE A 10 SPEED BIKE AND BICYCLE ACCESSORIES.

BIKES WILL BE CHECKED FOR SAFETY UNDER SUPERVISION OF PLYMOUTH POLICE DEPT.

**Saturday, May 21, at 2:00 P.M.**

**Plymouth Community Federal Credit Union**

500 S. HARVEY 453-1200

CLIP THIS COUPON AND BRING TO BIKE CLINIC.

Name \_\_\_\_\_ Age \_\_\_\_\_

Address \_\_\_\_\_

Parent's Permission \_\_\_\_\_

## Minitown teaches kids safety

BY DONNA LOMAS

Pre-kindergarten children in the Plymouth-Canton Community will get a chance this summer to learn about safety before they go to school - and they will learn it in a "town" called Safety-Town.

Safety-Town will soon be under construction in the Central Middle School parking lot, where four and five year old pedestrians and motorists will learn about safety. The town will be complete with pedal cars, buildings, crosswalks, streets, sidewalks and safety signals.

"Safety-Town is a two-week program which teaches safety to all four and five year olds," says Mary Popay of Canton, who initiated the Safety Town idea here. "The situations a child encounters when they go to school - crossing streets, traffic signals, safety belts, playground equipment, busses, strangers, even safety in the home - all these situations will be taught to the children - how to cope with and understand the multitude of safety hazards they will encounter."

Some of Mrs. Popay's children went through a Safety-Town program when they lived in Fairview Park, Ohio.

"I found the program to be extremely beneficial," she said. "I noticed a big difference in safety awareness between my own children that went to Safety Town and mine that didn't."

Mrs. Popay decided to see if a Safety Town could be star-

ted in Plymouth and Canton. She went to the school district's safety committee who approved the concept, and then took it to Larry Masteller, Director of Continuing Education who thought it was a good idea too, and decided to go to work on it.

A committee was formed for Safety Town, including Mrs. Popay, Masteller, traffic engineer Bob DeCorte from AAA, Plymouth policeman Joe Kahanec, State Police Trooper Dave Sass, Wayne County Sheriff officer Ron Brown and Lt. William Tomczyk, post commander of the Michigan State Police.

An elementary teacher, and eight safety instructors will be present at each session. There will be one instructor for five children enrolled. A police officer will be present for one hour each class day and a firefighter will be present on each second Tuesday.

Mrs. Popay said she was astounded at the response for assistance from the schools, civic organizations and local businesses. Without their help, she said, Safety Town would not have been possible.

"The program will be taught with the cooperation of the City of Plymouth, and the townships of Plymouth and Canton, along with the Wayne County Sheriff, Michigan State Police, Plymouth Police and all three fire departments," said Mrs. Popay.

The Plymouth Jaycees will paint the buildings in Safety Town, and the construction of them will be done by students from the construction class at Canton High School.

The Kiwanis will prepare the area at Central and paint Safety Town Streets. Graphic Arts students from Salem High and vocational design classes will design pamphlets to inform parents of Safety Town.

The Knights of Columbus will install seat belts in the cars and the Lions Club will renovate a garage close to

Central that will store the collapsible Safety Town when it isn't in use. Name tags for the Safety Town students will be prepared by Jayettes.

Mrs. Popay said sign posts will be donated by Unistrut Corp., and that the 20 or so pedal cars have been donated by Marino Chrysler, Jeannotte Pontiac, LaRiche Chevrolet and the Wayne County Sheriff's Union.

Three cars will actually be painted as emergency vehicles, said Mrs. Popay. One will be a State Police car, the other a City of Plymouth Police car and a third will be a Wayne County Sheriff's car replica.

The lumber for the building has been donated by the First National Bank of Plymouth.

"We have had unbelievable cooperation from civic organizations," said Mrs. Popay.

"We're amazed at the work all the people have put into this - it's much more than we ever expected."

But Mrs. Popay has one more community group in mind to assist with Safety Town.

"We need the senior citizens help," she said, "if they can come forward to serve soft drinks for the kids at Safety Town - the sessions are too long for children to go without a break - we would greatly appreciate it. We do want them to become involved with this safety project."

All pre-kindergarten students are eligible to enroll in the Safety town sessions. There is a \$5 fee.

Sessions will be from 10 a.m. to noon and from 1 to 3 p.m. from June 20 to July 1, June 5 to June 15 and from July 18 to July 29. Registration forms are available to parents and they may mail their form and check in or bring it to the Continuing Education Office at Canton High. Registration deadline is June 8. Registration forms will be available at kindergarten registration sessions.

**the Community Crier**

Published each Wed. at 572 S. Harvey St. Plymouth, Mich. 48170  
Carrier Delivered: \$8 a year  
Mail Delivered: \$11 per year  
Mailed at Controlled Circulation rates.  
Plymouth, Mich. 48170



Coming June 7-12

# All Canton joins to produce fair

There will be no Canton Jaycees Fair this year - - but instead, there will be the "Canton Fair," so named because of the community-wide involvement in the fourth annual festival, sponsored by the Canton Jaycees.

The fair will be located at the southeast corner of Ford and Lilley Roads.

Highlighting this year's fair will be bigger rides, the popular dunk tank, and a raffle featuring a 1977 car as first prize.

New this year is the Jaycee-sponsored Band Competition Night. Interested groups should contact Jaycee Mike Neal for more information.

An added attraction will be a Chamber of Commerce-sponsored Big Top involving local merchants.

Letters will be sent out by the Jaycees inviting local social, fraternal, and religious groups to participate in the fair. For a modest fee, groups may run sales, games or displays at the fairgrounds. Interested groups should contact Canton Jaycees Bill Ott or Don Carlson.

The Fair will be held June 7 through June 12. Proceeds from the event will be funneled back into the community via various Jaycee projects.

## SPECTACULAR PAINT & WALLPAPER SALE!!!



# 30% OFF ALL WALLPAPER

All the names you want: Thibaut, Sanitas, Schumacher, Wallclad, United DeSoto, J Josephson, Oldstone Mill and others.

## SAVE \$8.95 a gal

Buy one gallon of famous Dutch Boy Architectural Latex Semi-Gloss or Flat Enamel at the regular price of \$9.95 and get your.....

## 2nd GALLON \$1.00

Custom Colors available: add \$1.00.



## FLOOR FASHIONS of Canton

THE TOTAL HOME DECORATING CENTER

AREA'S LARGEST SELECTION OF CARPET, VINYL FLOORS, CUSTOM DRAPES AND BEDSPREADS, SHADES, SHUTTERS, WOVEN WOODS, WALLPAPER, PAINT, AND PAINTING SUPPLIES.

Open 9:30-9; Sun. 12-5

5854 Sheldon Rd, Canton

Corner of Ford & Sheldon in Harvard Square



459-6180



# GET MOM OUT OF THE KITCHEN WITH THESE BAR-B-Q SPECIALS

Parts for all Charmglow, Arkla, Structo Grills

We Handle the Mitts, Aprons & Tool Sets...

Headquarters for all your Bar-B-Q Accessories!

## EMBERMATIC GASGRILLS BY ARKLA

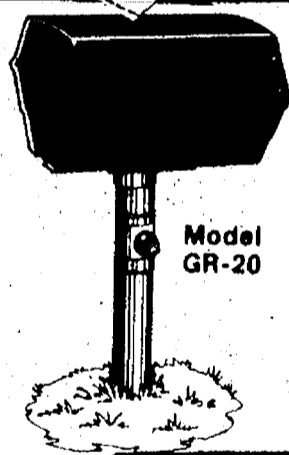

### FLAVORETTE

Including in ground post

REG. \$105.95  
SALE PRICE \$69.95

### Patio Range

GR-1717

732 SQ" of cooking space  
Cast Iron Cooking Grids  
Patato Rack

Includes In-ground Post  
also available with cart.

JUST LIKE MOM'S OVEN CAN BE USED FOR COOKING, BAKING, OR SMOKING

REG. \$395.95

SALE PRICED \$324.95

BY ARKLA

### Flavor Giant

Includes In-ground POst  
455 SQ" of Cooking Space  
Potato Rack, Cast Iron Burner  
AVAILABLE IN NATURAL OR LP GAS

REG. \$195.95  
SALE \$159.95  
MODEL GR-40

### FLAVOR TWIN

450-sq.-in. cooking area.  
Includes in-ground post.

REG. \$228.95  
SALE PRICE \$189.95

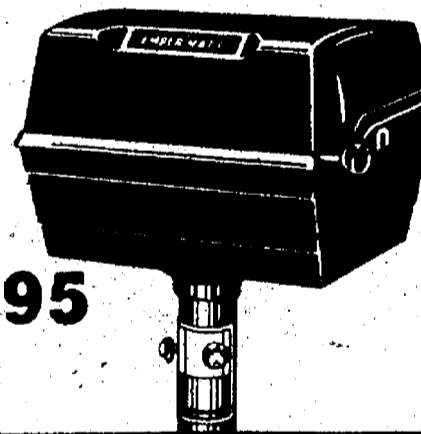

### FIREFLY

GR-20-123

Includes grill cart, L P tank

Reg. 139.95  
SALE PRICE

\$109.95

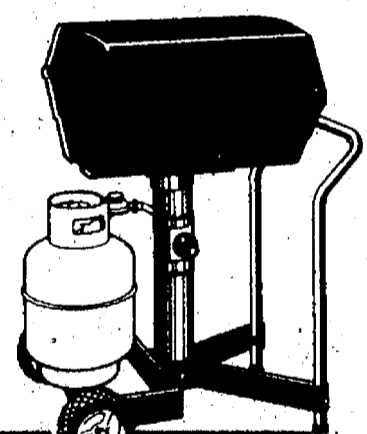

### Charmglow BARBECUE

MODEL 143201

### TWIN BURNER

461-sq. of cooking single control  
dual burner w/porcelainized cast  
iron cooking grids.

REG. \$254.95  
SALE PRICE \$195.95  
IN-GROUND POST INCLUDED



### Charmglow MODEL 1000

Certified by American Gas Association

Total cooking surface 235" sq in. Rated approx. 25000 BTU's per hour. You will never know it to look at it but this is our economy model. Same rugged construction as all the other Charmglow Barbecues just a little smaller and with a nickel plated cooking grid. But it still grills, smokes, barbecues and on top of that, does practically everything a kitchen range can do. Some economy model.

REG. \$134.95  
SALE PRICED \$89.99  
POST OPTIONAL

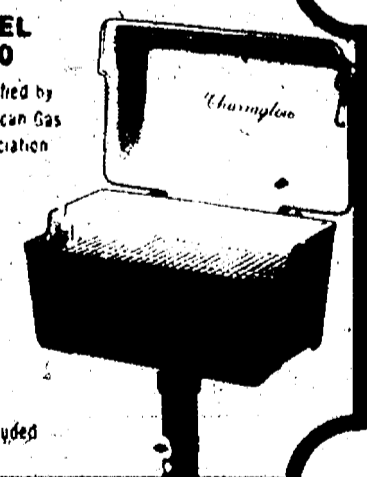

All Charmglow Grills feature solid cast Aluminum for year round use Grease Cup Holder, long lasting Charm-Roc Briquettes included

### ARKLA SUBURBANITE

MODEL GRD 30123

Heavy-duty Cast Aluminum Body; Includes: heavy duty cart, LP tank and fittings, permanent lava rock.

\$149.95

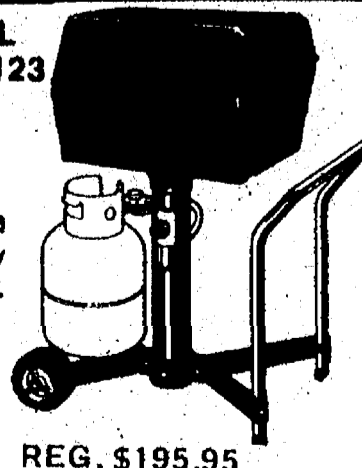

REG. \$195.95

### STEEL COVERED Cooker Model 7820

Bittersweet and black.

- 350 sq. in. cooking grid chrome plated
- Textured baked enamel finish
- Double lever smooth action hinges
- Adj. and remove fire pan and ash catcher
- Adj. upper and lower draft controls
- 1" diam. alum legs. Whitewax wheels

REG. \$39.95  
SALE PRICED \$34.95

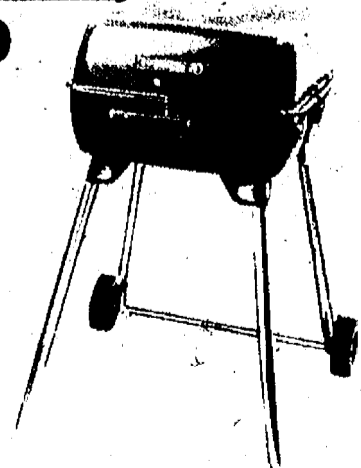

PONTIAC

2418 Elizabeth Lake North Oaks Plaza  
681-1828

BLOOMFIELD

1974 Woodward at So Lake Rd.  
335-3178

Store Hours: Daily 10-9 Sat 10-6

## Hearth Home

LIVONIA

3735 Six Mile at Newburg  
464-6040

CANTON TWP.

6074 Sheldon Rd. at Ford Rd.  
455-3240

Store Hours: Daily 10-9 Sat 10-6 Sun 12-5



**W** **M**  
**WITH** **A** **L** **I** **C** **E**  
**T** **O** **W** **A** **R** **D** **N** **O** **N** **E**

By **W. Edward WENDOVER**



## YAWN!

### School race unexciting

The Plymouth-Canton School election - - now just a month away on June 13 - - promises to be one of the least exciting in recent years.

Where in the past there've been tons of candidates, the single seat up for grabs interested only three candidates and they aren't very divided on the way things ought to be run.

There's still time to get a good war going among the three - - Arlene Calahan, Steve Harper and Mary Jane Mulaski - - but that's not likely.

Steve and Arlene have names familiar to most school watchers. They've been active in things before and that probably gives them quite an edge.

Geographically, Steve hopes to pick up the Plymouth-Plymouth Township votes as a favorite son, while Arlene and Mary Jane battle it out for the Canton votes.

Campaign wise, with the chairmanship of the schools' millage campaign committee, Steve has an organizational edge that can be beaten only if the gals get crackin'.

The district voters have never allowed three women on the school board at one time - - although Flossie Tonda's appointment more than a year ago broke that barrier. But will the voters replace outgoing E. J. McClendon with a woman? Certainly the gals in the running hope so, but they may cut each other's votes up trying to achieve that goal.

The next few weeks should tell us more, but don't expect any bombshells here.

Almost overlooked, but of import to us, is the Schoolcraft College election on the same ballot.

Only one Plymouth-Canton School District candidate is in the running - - Jack Bologna - - which means, since all his opponents are from Livonia, Plymouth's representation on the board is in jeopardy.

Leroy Bennett and Arch Valier, both served on the Schoolcraft Board but aren't seeking re-election which will mean we suffer the loss of at least one seat or two if Bologna doesn't win. More on that later.

Keep your eyes on the schools between now and June 13!



**SCALES OF JUSTICE**

**.... OR BALANCE OF POWER?**

## Canton should join Plymouth Comm. Fund

Canton's days as a quiet farm community are over, and it's still looking for a new identity.

Will it merge with the giant metropolitan area? Develop a separate identity? Or associate more closely with its established neighbor, Plymouth-Plymouth Township?

Many Cantonites fear that identifying with the Detroit metro area would leave Canton with no identity. Yet it seems to be growing too fast to create one of its own. Where is downtown Canton?

This leaves Plymouth. Cantonites have long thought of Plymouth as "theirs" and the school district provides a strong link between the two communities.

An issue has come up recently that mirrors the whole problem: Should Canton, without a Community Fund now, create its own, or join Plymouth's?

Presently, Canton residents give to the United Fund of the Metro Area mostly through where they work. While no exact figures are available, it seems clear most of their money does not make its way back to Canton because the people who distribute it are far away in Detroit.

For example, Jim Sinclair, president of the Plymouth-Canton Junior Athletic Assoc. (PCAA) called the metro United Fund five times, long distance, to see about getting money to support the Canton kids' par-

Page Six

# Community opinions

THE COMMUNITY CRIER: May 11, 1977

icipation in the association. Each time they put him on hold so long, he said, that he had to hang up.

Canton needs local residents allocating local money for local needs.

The next question, then, is: should we start a new organization or join Plymouth's established and successful one?

We believe Canton should join Plymouth's. This would avoid a costly duplication of administration. A combined Plymouth and Canton fund would be locally run to insure the money was spent where it was needed.

A combined fund would also tighten the bonds between the two communities, something we strongly endorse.

THE COMMUNITY CRIER

### Cooks like photo

EDITOR:

We were so happy that you could visit our PLUS Preschool Program and watch the children do their thing with cooking. The picture in the paper was just great and we have one posted in the preschool room and in the parent's room.

Try out some of our recipes from the book!

MARY FRITZ  
Project Director

PLUS Preschool Title I ESEA

### City lights waste money

EDITOR:

As I drive up Main Street after dusk I can take one look and be assured our Historical Museum operates on private funds. How can I tell?

First the Library - then City Hall, lights glowing on tax-

payer's dollars. Then the Museum with just a porch light as a beacon, because the Historical Society is hard-put to pay those utility bills!

Take a look one evening.  
DETTV ZIMMERMAN

**the Community Crier**

"THE NEWSPAPER WITH ITS HEART IN THE PLYMOUTH-CANTON COMMUNITY"

572 S. Harvey St. 453-6900 RECYCLE YOUR  
Plymouth, Mich. 48170 NEWSPAPERS

Editor & Publisher	W. Edward Wendover
Asst. Editor & Sports Editor	Donna Lomas
Advertising Director	Mark Ferraiuolo
Photo Editor	Susan Sheiner
Reporter & Production Manager	Chas. Child
Asst. Sports Editor	Matt Norris
Advertising Consultants	Fran Hennings
	Mike Carne
Circulation & Office Director	Phyllis Redfern
Business Manager	Melanie Robinson
Typesetter	Dawn Boegler

PUBLISHED EACH WEDNESDAY

Carrier delivered:	70 cents monthly
	\$8 yearly
Mail delivered:	\$11 yearly

Member Mich. Press Assoc.





# Shield Construction Co.

400 N. Main Street  
Plymouth  
455-6350

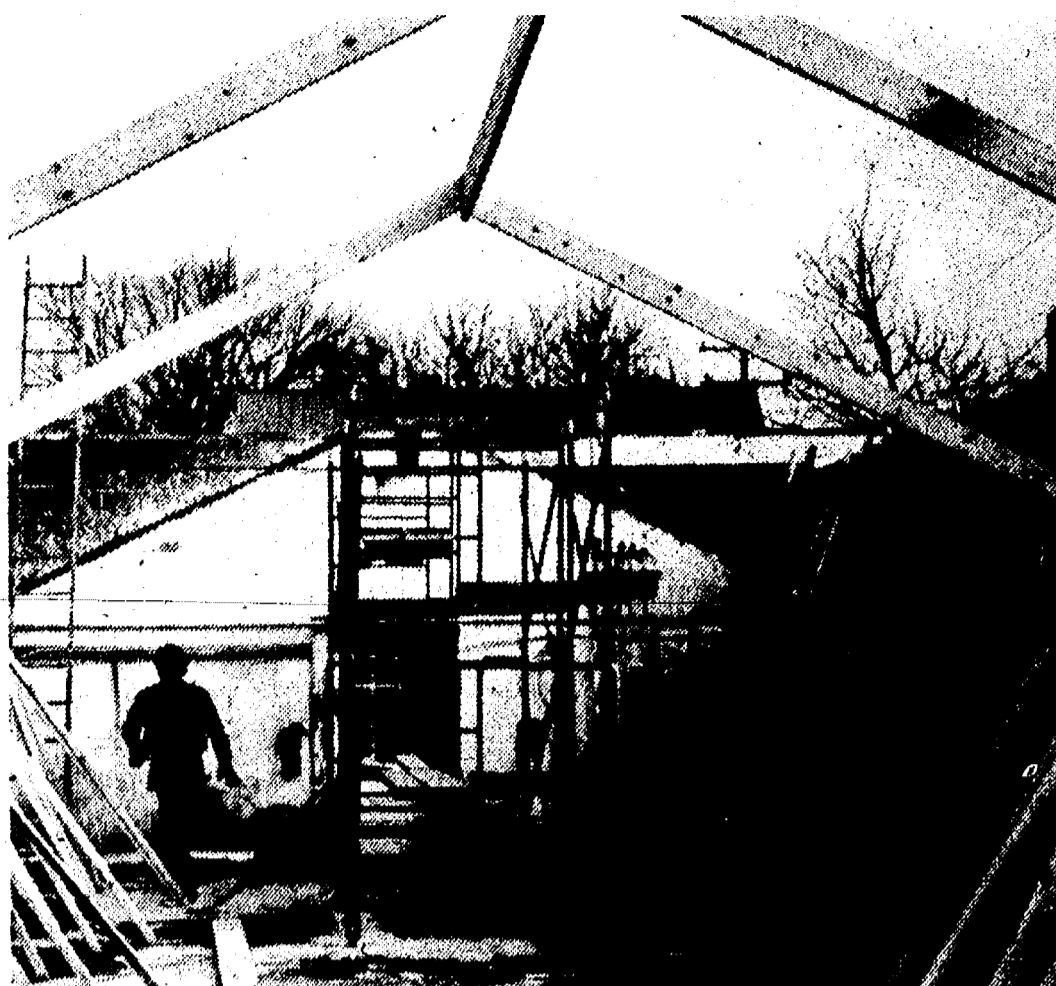

Tradition has importance and high goals are set in our community, where the hopes of tomorrow are achieved...today. This is true of The Old Village Association.

A dream that began seven years ago will be a step closer to reality when work is started in Old Village with the laying of the cobble stone walks and a new garden area on Farmer Street. Here the trees and flowers with the charming gazebo and inviting benches will tempt all to stop awhile and enjoy this lovely garden.

Private businesses in Old Village has always kept up with the visions of pride and beauty held by the members of the Old Village Assoc., and the re-opening of Heide's Greenhouse Garden Center is the latest architectural improvement.

The Old Village Association met seven years ago at the House of Glamour with Doug Blunk, Milton and Roberta Orr, Fran and Chris Kontos and Pat and Bill Hann present. Their guests were the City Commissioners whose members toured this area once referred to as "Lower Town". They saw abandoned cars, run-down houses, ugly vacant lots and debris. The determination to clean up the area and then beautify it, seemed like an insurmountable goal, but these tasks were done. The dues of \$12.50 prevail today providing little money, but the dedication of this group along with new members, can never be measured in dollars. Pointe Park was the first major project after the clean up. With the kindness and assistance of the Garden Clubs the park insured a beautiful entrance to the Old Village area, and for the entire community. Hedges, flowers and flowering trees would invite many in the community to enjoy the downtown area too.

With the growth of the association came art shows, sales, antique and bake sales, and finally the perfect answer for Old Village - - their own Dearie



Day. With prices to tempt parents, and parades, food and game to thrill children, this was a unique way to acquaint people with this now lovely part of town. Everyone enjoys the atmosphere while shopping during the day, and are enchanted with dancing under the stars in the artfully decorated parking area of Heide's Greenhouse Garden Center at night. All moneys earned are re-invested into Old Village in improvements. Businesses have decorated their homes with imagination and care. Heides Greenhouse Garden Center has been transformed from the wind-and-rain damaged place pictured three years ago to the seven exciting businesses - - Heide's Flower Shop, Austin Vacuum, Wilwood Imports, Old Village Sausage Shop, The Village Stripper, Millers Upholstery and Heide's Garden Center - - of today under one roof. The Greenhouse, the first in Wayne County started in 1899 by Carl Heide, will Bill Ruhr carrying on the fine traditions established by him.

Many of the improvements you see in our area, as well as at Heides Greenhouse Center and others in Old Village can be attributed to the careful adherence to tradition of the Shield Construction Company and Joe Crothers. He feels working in this area requires dedication to the past in design and modern technology in structure, to assure today's high standards.

Heides Greenhouse Center will re-open with a full line of garden supplies and will be managed by Joanne DeMino, who brings to the Old Village area 25 years experience in retailing.

Special thanks must always be included for the city officials who so generously cooperate with owners to assure high quality as well as fine traditions.

Special thanks, too, for all the "unsung heroes" who have also labored long and hard to make Old Village the beautiful place it is today.

COURTESY OF JOSEPH CROWTHER  
SHIELD CONSTRUCTION CO.

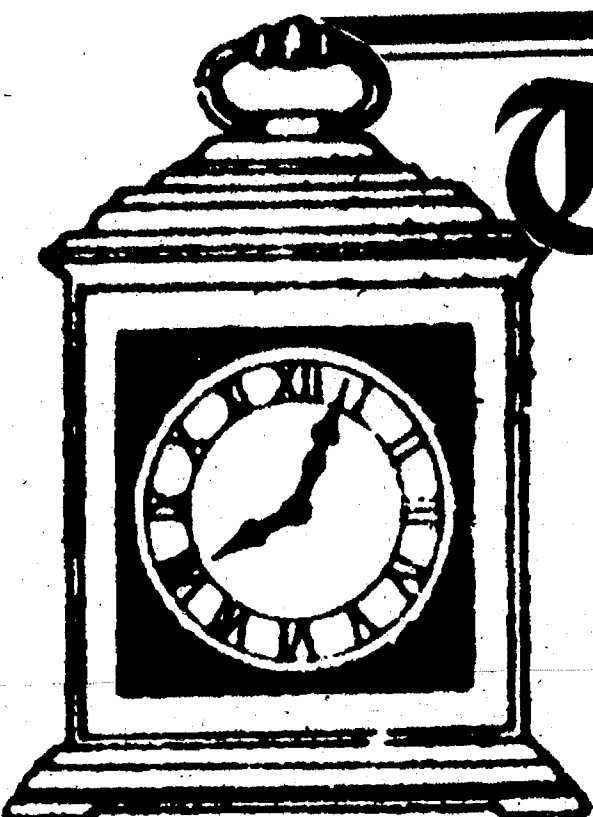

# The Clock

9468 South Main St.  
Plymouth

## the 24 hour Restaurant

**Breakfast - Lunch - Dinner  
Served Anytime**

- Delicious food 24 hrs. a day
- Family dining

459-3780

Ann Arbor Rd.  
Main St.  
9468 S. MAIN  
PLYMOUTH

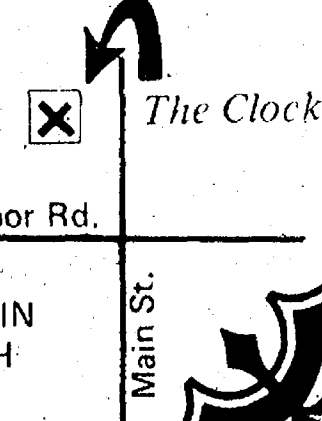

## What's happening

### LA LECHE BAKE SALE

Home-baked bread and other healthful treats will be sold Saturday by the Plymouth-Northville La Leche League. The bake sale will be from 9 a.m. to 2 p.m. at the entrance of the Kroger supermarket, Sheldon and Ford Roads, Canton. Proceeds from the sale will help offset costs of training sessions for league leaders who offer breastfeeding counseling on a nonpaid basis. Also available at the sale will be the cookbook, "Mother's in the Kitchen" featuring recipes from La Leche League members all over the United States and world. Leaders will be present to provide information for those interested in or who are breastfeeding their babies.

### ERIKSSON FUN FAIR

The Eriksson School P.T.O. (Parent-Teacher Organization) will hold its first Fun Fair on Saturday, May 14, from noon to 4 p.m. at the school, 1275 N. Haggerty Rd. Tickets can be purchased the day of the fair for 15 cents.

### BEGINNER KARATE IN CANTON

Canton Township Parks & Recreation Department is sponsoring Isshinryu Karate classes for ages 9 and up. Lessons will begin any Wednesday from 8 - 9 p.m. in the Recreation Center, 44237 Michigan Avenue, corner of Sheldon Rd. The class will be held for 10 weeks with a registration fee of \$20. Learn to defend yourself in Karate taught by Sam Santilli of Canton Township. For registration call the Recreation Office at 397-2777.

### CANTON POSTPONES GARDEN REGISTRATION

Due to many days of rain in the past two weeks, the Canton Township Recreation Department informs the public that the registration of Garden Plots will be postponed. We have cancelled the registration on May 10 and moved it up to Monday, May 16 from 7-10 p.m. in the Recreation Center, 44237 Michigan Ave. and Sheldon. After May 16, registration will be taken in the Recreation Center at regular office hours, Monday - Friday from 8:30 a.m. to 5 p.m.

### APPLE RUN GARDEN CLUB NEW OFFICERS

The Apple Run Garden Club division of the Women's National Lawn and Garden Assoc. will meet at the Hillside Inn for dinner on Monday May 16 at 7:30 p.m. The installation of new officers will be attended by a representative from the Plymouth branch. For more information call Cheryl Wachlurg at 453-7424.

### DAUGHTERS OF THE AMERICAN REVOLUTION

The Sarah Ann Cochrane Chapter, Daughters of the American Revolution, will meet Monday, May 16 at noon at 38125 Base Line Road for a sandwich luncheon. The program will be "Greenmead" Livonia's Historical Landmark Farm Home. The speaker will be Mrs. D. H. Baumhart. State awards report will be given.

### ISBISTER SCHOOL

Is having a Visiting Day for newly enrolled kindergarten children on May 16. Residents of Isbister attendance area who have not yet registered their children for kindergarten contact the school before that date.

### V. F. W. POPPY DAY

Veterans of Foreign Wars Post No. 6695 will hold a Buddy Poppy Day on Thursday, May 19. For further information call Avis Truax at 453-0209.

### ICE CREAM N' ART

Smith School will hold their annual Ice Cream Social and Art Fair on Tuesday, May 17, from 6-8 p.m. in the school. Ice cream cones will be sold and student art-work will be on display throughout the building. For further information call Kari Miller at 455-0630.

### THEATRE GUILD PRESENTS COMEDY

The Plymouth Theatre Guild will present Jack Sharkey's comedy "A Gentleman and a Scoundrel" on May 13, 14, 20 and 21, at 8:30 p.m. in the Central Middle School. Tickets are \$2 for children and senior citizens; \$3 for adults and can be purchased at the door.

### CHRISTIAN WOMEN'S CLUB LUNCHEON

The Christian Women's Club will hold a "Rainbow Reflections" luncheon on Thursday, May 12 from noon to 2 p.m. at the Mayflower Meetinghouse on Main Street. Cost of the lunch is \$4.25 and will feature stained glass presentation and a performance in music by a selected soloist. The speaker will be Janet Price. For further information call 425-8474 or 522-1528. Luncheon reservations must be called in by May 5 to the above numbers.

### GROWTHWORKS PAPER DRIVE

Growthworks, Inc. will be having a paper drive Sat., May 21 from 10 a.m. to 5 p.m. at the Youth Center. The Center is located at 271<sup>st</sup> S. Main in Plymouth. We will be taking newspapers (newspaper only please) from 2:30 p.m. til 9:30 p.m. weekdays at the center until the day of the drive. If you are a resident of the City of Plymouth, Plymouth Twp., or Canton and would like papers picked up at your home please call 455-4090 or 455-4095 weekdays. Pick-ups will be made on Fri., May 20 and Sat., May 21. This fundraising activity will be held every other month so save your papers for Growthworks.

### PLYMOUTH NEWCOMERS ROAD RALLY

Friday May 13 at 7:15 p.m. Will meet at the Cultural Center Parking lot. - Reservations call Sandi Page 459-3568 by noon on May 9. Cost is \$12 a couple and will include a party at the end of the rally with pizza, beer and mix with cash prizes to the winners. Rally is open to all members, ex-members and guests.

Watch  **the Crier**  
for legal notices from:  
**Canton Township**  
**City of Plymouth**  
**Plymouth-Canton**  
**School District**  
**Plymouth Township**

The Community Crier has been designated as a legal notice publication by all four of the local governmental units in the Plymouth-Canton Community. These notices and minutes of the official meetings may be of interest to our readers who are watching for a specific item such as bids, or the progress of a rezoning. To get this official local governmental news, in addition to the best local news, features, opinions, sports and advertisements.

**Get**

 **the Community Crier**

**For Home Delivery,  
call 453-6900**



# What's happening

## DELTA ZETA INSTALLATION

The Western Wayne alumnae of Delta Zeta sorority will hold their 8th Annual Installation Banquet at 6:30 May 18th at the Hillside Inn in Plymouth. Mrs. Carl Holmes of Dearborn will be installed as chairman; Mrs. Thomas Lang of Northville as vice-chairman; Mrs. William Ryan of Farmington as secretary; and Mrs. William Bruce of Plymouth as treasurer. Mrs. Robert Silber of Plymouth is chairman of the banquet committee and those planning to attend should call her at 459-4166.

## SCHOOLCRAFT INVITES ARTISTS

Local artists and craftspersons are invited to participate in the Schoolcraft College Art Fair running from July 14 to July 16, 1977. The fair will be held on the Campus Mall between the Administration Building and the Forum Building from 1 to 7 p.m. each day. Artists and craftspersons in all media who wish to display and/or sell their work should call or write to Arthur Lindenberg before June 13. His number is 591-6400, ext. 441.

## SENIOR CITIZENS MAY TRIP

May trip is to historic Henry Ford Museum. Bus leaves the Cultural Center at 10:30 a.m. and returns at approximately 4 p.m. Cost is \$3 which includes transportation and admission to the Museum. Lunch at Museum is extra. For more information contact the Recreation Department at 455-6620.

## PLYMOUTH PATHFINDERS TRIP TO IRISH HILLS AND HIDDEN GARDENS

The Plymouth Pathfinders are planning a trip Saturday, June 25. Leaving at 9 a.m. from the Cultural Center and returning about 5 p.m. A picnic lunch will be held at Wampplers Lake. Everyone is to bring their own food and beverage. Wear casual clothes. Cost of trip is \$11.75. We will be going by air-conditioned motor coach. Everyone welcome. Please call the Parks & Recreation Dept. at 455-6620 for further information or stop by 525 Farmer Street, no later than June 10th for reservations.

## LOWELL SHOWBOAT TRIP -- TUESDAY, JULY 26

The Plymouth Parks and Recreation Dept. announces its annual Lowell Showboat Trip to be held in July. Two busses will leave the Cultural Center at 10:30 a.m. on Tuesday, July 26, and return at approximately 1:00 p.m. on Wednesday, July 27. Accommodations are at the Grand Rapids Holiday Inn. Dinner is included in the package. Pearl Bailey will be performing on the Showboat. This trip is open to all senior citizens and interested adults. Total cost is \$35.00.

## TABLE TENNIS CLUB

The Table Tennis Club will meet each Tuesday evening at 7 p.m. at the Cultural Center.

## PLYMOUTH FIGURE SKATING CLUB

The Plymouth Figure Skating Club meets at the Cultural Center on Monday night from 8-11 p.m., Friday night from 7:30 - 10:30 p.m. and Saturday evening from 6-8 p.m.

## PAINT FOR FUN

Paint for fun invites those who are interested in oil painting to meet each Thursday in an informal setting from 1-3:30 p.m. at the Cultural Center. This class is free to all who attend. Contact Fred Prussing at 455-8894.

## PLYMOUTH ROCK AND MINERAL SOCIETY

The Plymouth Rock and Mineral Society meets on the first Monday of each month at 7:30 p.m. at the Cultural Center.

## LAKE POINTE BRANCH FARM AND GARDEN

The Lake Pointe Branch of the Woman's National Farm and Garden Assoc. will meet on May 12, at the home of Joanne Gray at 7:45 p.m. Topic for the evening will be "Quilting" as demonstrated by Ana Chinn.

## BIRD SCHOOL SPRING GROUNDS WORKDAY

And Annual Hot Dog Roast will be held Tuesday, May 17 beginning at 5:30 p.m. Dads, especially, are needed to help build 8 new pieces of playground equipment, but help is needed from kids and Moms too. See you there!

## ANNUAL BUSINESS MEET

The Plymouth Historical Society will hold their Annual Business meeting in the lower level of the Museum, Thursday, May 12, following a pot luck dinner at 6:30 p.m. Officers will be elected and members are urged to attend. It is requested that there be no visitors at this meeting.

## CANDIDATES SPEAK

Arlene Callahan, Steve Harper and Mary Jo Mulaski, candidates for the Plymouth-Canton Community School Board, will be addressing themselves to such issues as the pros and cons of our school system, at the next meeting of the Plymouth Assoc. for the Academically Talented. This meeting will be held Thursday, May 12 at 8 p.m., in the library at East Middle School.

## ART STUDIO CONFERENCE SCHEDULED

A unique "Studio Conference" for art students and teachers will be held at the Education Center of the Wayne County Intermediate School District, 33500 Van Born Road, Wayne Michigan on Friday and Saturday, May 13 and 14. Teachers and students will have the opportunity to work with a number of different materials as well as hear lectures and view demonstrations on various art forms. This is believed to be the first conference of this type to be held in Southeastern Michigan. Sponsored by the Intermediate School District, with financial assistance from the Michigan Council for the Arts, the meeting will bring the best Wayne County practitioners together.



## OLGC hosts fashion follies

THE STYLES OF THE SEASON were featured last Wednesday night when the Rosary and Altar Society of Our Lady of Good

Counsel Catholic Church presented a Mother and Daughter Banquet and Fashion Show at the church. (Crier photo by Susan Sheiner).

## State Police to hold Open House

The State Police Northville Post will hold an Open House on Tuesday, May 17, from 10 a.m. to 8 p.m.

Highlights of the event include guided tours of the post, the crime laboratory, and continuous showings of the film "Preserve, Protect and Defend." A State Police helicopter, bomb truck, and patrol unit will also be on display.

The Northville Post is located on Seven Mile Rd., east of Northville Rd. The public may attend.

**McAllisters**  
Your Complete Beverage Store  
On Northville Rd. opposite Plymouth Hilton  
7 a.m. - 11 p.m.  
455-9363

Beer \* Package Liquor (incl. 1/2 gal. & gallons)  
\*Over 200 types of Domestic & Imported Wines  
\*Champagnes \*Meats  
\*Keg Beer \*Groceries

## FUN DAYS AHEAD... for the younger set

featuring NAME BRANDS



## Playwear Separates Jackets

*Minerva's Dunning's*

WOMEN'S & CHILDRENS WEAR

500 FOREST, PLYMOUTH GL 3-0080

Free Parking rear of store - Hours: 9-6 Daily Fri. 9-9



# Gallimore gets grandfolks

BY DONNA LOMAS

A brand new program at Gallimore Elementary School has made some brand new persons out of the young and elderly alike.

The "Grandpersons" program at Gallimore was started six weeks ago by librarian Kathy Schmidt, who says the idea came from a larger, federally funded program in Ann Arbor. "Grandpersons" is a program in which senior citizens come into the school and share their lifetime of experiences and skills with students in the fourth grade.

After attending one of the workshops in Ann Arbor, Ms. Schmidt came back with a few ideas of her own for Gallimore.

"I thought it was such a worthwhile program," she said.

## the Crier's friends & neighbors

"Worth While for everyone. I was so entused about the idea, I decided to get something started here."

The fledgling program is small now, but Ms. Schmidt hopes to involve more seniors as it progresses.

Sessions in crocheting, tying knots, a nature walk through

the woods to identify flowers and trees, even animals - - these are all part of Grandpersons. One grandperson even initiated a filming of a short movie with his group.

Sessions are limited to small classes of ten students to a grandparent.

"The kids like it and look forward to the sessions," said Schmidt. "Some seniors were a little hesitant about coming at first - - they were surprised someone was interested - - but now we have three people coming regularly and hope to have more soon."

"Ideally, we need six on a regular basis. The amount of time they spend is up to them," said Ms. Schmidt, "so are the number of students in their session."

The biggest obstacle the program had at first was transportation. The YWCA offered a van for use on Tuesday mornings, a "marvelous" solution to the program's first problem.

Parents and teachers are paying for supplies and lunches, says Ms. Schmidt, and other volunteers help out on the lunchline.

"It is a rich relationship for seniors and the children" said Ms. Schmidt. "Everyone benefits from the older - - and younger - - wisdom.



FIGURINE PAINTING is just one of the skills taught by grandparents in the Gallimore School Grandparents Program. Here, grandmother Louise Bradley gives fourth-grader Jill Kirchgatter a hand with the paint brush. (Crier photo by Susan Sheiner).

### EVENING MEDICAL CARE, P.C.

After hours medical care for the treatment of illness, injuries, and minor emergencies.

OPEN 7 DAYS A WEEK  
Mon-Sat 5-10 p.m.  
Sundays & Holidays Noon - 5 p.m.

CANTON  
PROFESSIONAL PARK

8552 N. Canton Center Rd.  
Canton Township, Mi. 48187  
455-4040

# FREE

## HOW-TO-HANG WALLPAPER demonstration

### Wed. May 25, 1977

10am-12 NOON

Please call or Stop by to Register

FREE refreshments- Door Prizes

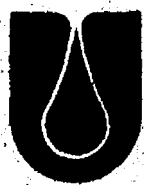

UNITED PAINT DECORATING CENTER

44610 Ford Rd. at Sheldon  
in the New Town Plaza  
Canton 455-0250



Hours: Mon. & Fri. 7:30-9:00  
Tues., Wed. & Thurs. 7:30-8:00  
Sat. 9:00-5:00

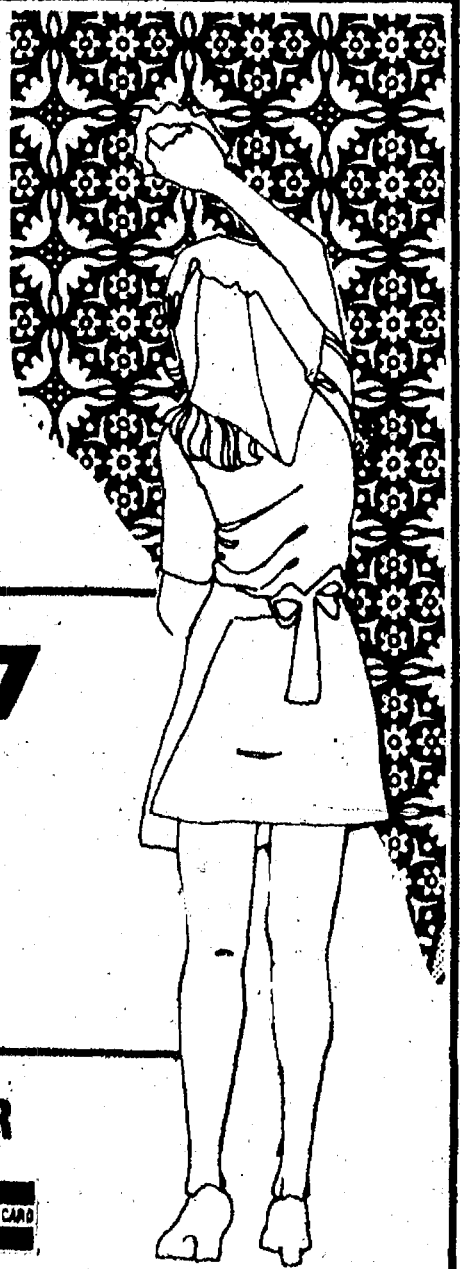

## Blue Ribbon survey begins May 14

The Blue Ribbon Study Committee on Aging reports that 100 volunteers have been recruited to conduct a door-to-door survey of senior citizen needs.

The survey will be held from May 14, through May 21, and it will include questions on the health, nutritional, housing, and recreational needs of Plymouth residents 60-years-old and over.

"By including persons as young as 60 in the survey we will have data in the city plan not only for immediate needs but for

future senior citizens as well," said a Blue Ribbon spokesperson.

All volunteers will attend training sessions which will be held on Wednesday, May 11, at 1:30 and 7:30 p.m.; Thursday, May 12, at the same times, and Saturday, May 14, at 11 a.m. All sessions will be held at the Cultural Center except for one at City Hall. Seniors who have not been contacted by one of the volunteers are requested to call either City Hall at 453-1234 or Scott Dirk at 455-8836 for an interview.

## Irene Osowski to wed



Mr. and Mrs. Eugene Osowski of Parkdale, Livonia, have announced the engagement of their daughter, Irene Lynne to Joseph Alvin Langkabel, son of Mr. and Mrs. Leigh Langkabel, Jener St., Plymouth.

The bride-elect is a graduate of the Ladywood High School Class of 1974. She is employed at Grandma's Take Home in Plymouth.

Her fiance is a 1975 graduate of Plymouth Salem High School, and is the owner of Grandma's Take Home.

A Sept. 23 wedding is planned for St. Michael Catholic Church, Livonia.



# State audit says: Greenstein misspent \$\$\$\$

Cont. from Pg. 1

were adopted by the Canton Board of Trustees in October, 1975.

Stein said he did not want to make any charges until the state attorney general's office makes its report. "But, the report raises a lot of questions,"

The auditors also said Greenstein amended the township's pension plan without board approval, which benefitted Greenstein and former Treasurer Carl Parsell.

Under the original provisions of the pension plan, township employees were eligible to join the plan every July 1 of each year, regardless of when they started working for the township.

Greenstein amended the policy so he and Treasurer Carl Parsell would be eligible right from their inauguration date in November, without having to wait until July 1, 1975, the report says.

Stein has ordered payment of the pension withheld for Green-

stein and Parsell until the township's attorneys rule on the pension charge's legality.

Greenstein said all these expenditures were in the approved budget. "No checks were paid out or obligations incurred that were not approved by the Board of Trustees."

Greenstein said, "I didn't make any amendments to the pension plan. I know nothing about them."

In conclusion, Greenstein said, "I found it astounding that the auditor who did this

report did not even talk to me about his investigation."

Parsell said the pension plan was changed to make it fair. He said if an employe was hired July 2 he would have to wait a whole year join the plan. "Yes, I benefitted from the change, but so did all the other employes. Also, federal regulations required that we make the plan fair."



## Growth threatens school quality?

After much quibbling, the Plymouth-Canton School Board served notice Monday that the rapid growth seen in Canton and Plymouth Townships may threaten the quality of education in this school district.

Discussing a resolution introduced by Board Member Tom Yack two months ago, the board argued over Yack's wording which placed blame for "uncontrolled" growth on the townships.

Yack said, "growth is jeopardizing our ability to provide both facilities and programs." He said local governmental units don't mind growth because it produces increased tax revenues for them although the school district receives a loss in state aid corresponding to local tax increases.

Board Member E. J. McClendon said he agreed with Yack in principle but objected to saying the growth was "uncontrolled" and would necessarily hurt quality of education. He proposed adding the word "may threaten" and deleting "uncontrolled".

Flossie Tonda, a board member who formerly served as a Canton Planning Commissioner, said she thought Canton was not to blame for educational problems resulting from growth. "We, as school board members are responsible for them. We can't blame the other units of government."

The board voted unanimously on McClendon's amended version of Yack's resolution. Member George Lawton was absent.



A GENTLEMAN AND A SCOUNDREL will be presented by the Plymouth Theatre Guild May 13, 14, 20 and 21 at 8:30 p.m. in the Central Middle School. Tickets are \$2 for children and senior citizens; \$3 for adults. Thomas Hjnks in the dual role of Fred Dixon/Rick Laredo and Carole McNulty as Jennie Corell will lead the cast. (Crier photo by Susan Sheiner)

## Teacher pact snag fixed

A last-minute snag in finalizing a contract between the Plymouth-Canton School District and its teachers, was apparently resolved late Tuesday afternoon.

Both sides disagreed on whether salary hikes and cost of living adjustments in the third year of the proposed contract would be compounded. It was settled Tuesday that they would be compounded - which could cost the district a total of \$20,000 for the pact.

Because of the last-minute disagreement, the Plymouth Education Assoc. has postponed its ratification meeting from this Thursday to next Tuesday.

## Smith collapses

Royce Smith, the Wayne County Commissioner whose district includes The Plymouth-Canton Community, was hospitalized over the weekend after he collapsed Friday night.

Smith, was released from Wayne County Hospital Sunday after being kept for observation in the coronary care unit, said he was feeling better and put in a full day's work Monday.

## Jim promoted

James Mathias of Plymouth was recently named director of the McKenny Union and Conference at Eastern Michigan University.

Mathias is in charge of the Union food service, conferences, and reservations for all university facilities.

## Give us the test we fix 'em best

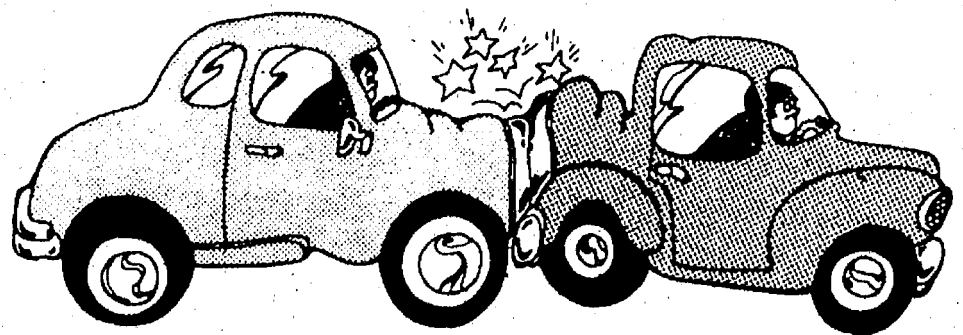

## MASTER COLLISION SHOP, INC.

COMPLETE FRAME STRAIGHTENING FACILITIES

- Expert collision service - free estimates • Foreign car repairs
- Corvette & fiberglass repairs • Modern paint facilities
- Custom painting available • All types of auto and truck glass installed • All work guaranteed • Towing

Halo  
**RUSTY JONES**  
Goodbye rusty cars.

Ask about our guarantee

RUSTPROOFING.....

THAT PROTECTS

**\$10 OFF**

Call me about the best auto rustproofing guarantee in town.

If you're buying a new car, here's your chance to save on the resale value of your car at trade-in time.

with this coupon

OPEN DAILY 8a.m.-6p.m.  
SATURDY 8a.m.-12 Noon  
300 INDUSTRIAL DRIVE  
PLYMOUTH, MICHIGAN 455-4400



## The Cutting Quarters

when your Hair Looks and feels Better so will You...

**Our Staff of talented Hair Stylists**

can give You the Style that is Best for You...

**WE'LL STYLE, CONDITION, PERM, HENNA YOUR HAIR TO CREATE A NEW**

**Fashion Look for You...**

685 W. ANN ARBOR TR.  
PLYMOUTH

CALL FOR RESERVATIONS  
459-0640

# MACLD to discuss learning disorders

**Laurel FURNITURE**



**BEDROOM FURNITURE**  
ALL STYLES & FINISHES  
584 W. ANN ARBOR TR. PLY  
Open Daily 9:30-6 P.M.  
Thurs - Fri. til 9 P.M.  
453-4700

The Plymouth-Northville Chapter of MACLD (Michigan Association for Children with Learning Disabilities) will meet on Wednesday, May 18 at 7:30 p.m. at Pioneer Middle School, 46081 Ann Arbor Road, in the cafeteria.

Carole Gimble, M.A., Coordinator-Children's Services, Speech Pathology, Wm. Beaumont Hospital and Kathy Ventre, M.A., Children's Services, Staff Speech Pathologist, "Early Detection of

Learning Disabilities Through Receptive and Expressive Language Output. Focus on Preschoolers." will be the topic.

Ms. Ventre is an active member of the American Speech & Hearing Assoc., Mich. Speech Pathologists, Mich. Assoc. for Chil-

dren with Learning Disabilities and consultant for the Neuro-Education Center at Wm. Beaumont Hospital.

Ms. Gimble is a consultant at the Neuro-Education Center at Beaumont Hospital. She is Vice Pres. in Programs for the

MACLD for the Farmington Chapter, and is the President Elect for the Mich. Speech Pathologists in Clinical Practice.

A disabled learner may exhibit disorders in thinking, talking, listening, coordination, reading, writing, spelling, or arithmetic, according to the MACLD.

"He may have behavior problems, but he is not primarily emotionally disturbed,

physically handicapped, blind, deaf, or retarded. His is a "Hidden Handicap" and he can be helped," said MACLD spokesperson, Margo Panko.

The local MACLD chapter seeks to inform parents, teachers, and the public on specific problems of children with educational handicaps. Meetings are open to anyone interested in learning more about the children and what help can be given them. They are free of charge.

## Canton Rotary to get charter

The Canton Rotary Club will receive its official charter on Monday, May 16 at the Mayflower Meetinghouse.

A gathering of all Rotary Clubs in the tri-county and Windsor district will install officers at the official dinner presentation.

Speakers for the event will be Hugh Hatcher, president of Rotary International and a governor of Rotary.

The Rotary Club organization is a service organization which deals with fellowship and friendship among businessmen. Their purpose is to strive to improve community services in their local area.

The Plymouth Rotary Club

sponsored the Canton Rotary, which recently passed the 20-member mark making them eligible for an official Rotary Charter. The Canton Rotary has 23 members.

Canton Rotary officers who will be installed May 16 are all Canton businessmen. They are: John Schwartz of Schwartz' Greenhouse; vice-president Bill Brown of Bill Brown's Auto Clinic; Treasurer Bill Tesen, of Wayne Bank on Ford Road and Secretary Mike Bowler, of Meijer's Inc., of Canton.

The Canton Rotary Club meets every Monday at noon in the Roman Forum Rest. on Ford Road in Canton.

## Food stamps available

A food-stamp program to insure a proper diet primarily for pregnant and nursing women, infants, and children up to the age of five is available in Wayne County.

Senior citizens and others who may be nutritionally deficient may also be eligible.

There are only 2,000 people per month participating in the program originally planned for 5,000; according to Canton Supervisor Harold Stein.

Those who think they may be eligible should contact the Wayne County Department of Health, 274-2800, ext. 234.

**IN THE OLD VILLAGE ITS**



**Bill's Market**  
584 STARKWEATHER  
PLYMOUTH - 453-5040  
GROCERIES - MEATS  
BEER & WINE TO TAKE OUT  
PARTY SNACKS • SANDWICHES • DELICATESSEN

For Patios-Porches-Boat Docks



**Grass Carpet**

CHOOSE FROM 4 COLORS

SEE HOW LITTLE IT COSTS TO DO THE AREA YOU WANT	Reg. \$5.95
	SALE PRICE
9X12	\$57.00
12X12	\$76.00
12X15	\$95.00

**\$4.79** Sq. Yard

**Plymouth Rug Cleaners, inc.**  
1175 STARKWEATHER  
PLYMOUTH • 453-7450

## Circus in town this weekend

The third International Plymouth Community Chamber of Commerce Circus will be this weekend, Saturday May 14 and Sunday May 15.

Tickets are available at the Penn Theatre, 760 Penniman; Jerry's Bicycles at 1449 Ann Arbor Road; and the Plymouth Community Chamber of Commerce, 878 Wing St.

Complimentary tickets must be

exchanged for a specific day and date ticket no later than tomorrow (Thursday, May 12) Each performance has specific tickets, different this year from last - in the past a circus ticket was good for any show.

Show times on Saturday are 1 p.m., 4 p.m., and 8 p.m. Sunday's performances are at 1 p.m., 4 p.m. and 6:30 p.m.

## Weidman-Parker vows spoken

Karen Weidman, of Plymouth and Randall J. Parker of Battle Creek, were married at the First United Presbyterian Church March 26 in an afternoon ceremony.

Mrs. Parker is the daughter of Mr. and Mrs. Robert G. Weidman of 13274 Drury Lane in Plymouth. Parker is the son of Mr. and Mrs. Ralph W. Parker of Battle Creek.

Rev. Philip Magee officiated at the ceremony. Maid of honor was Jennifer Hewins and attendants were Judy Cochrane, Dixie Sloan and Pam Parker. Best man was Ken Pero and ushers included Scott Parker, Chris Wells and Dennis Cotcamp.

The couple are living in Battle Creek.



UN-WIND. RELAX. EASE OFF. LAY BACK AND LET THE DAY GO AWAY WITH 2 DRINKS FOR THE PRICE OF 1 FROM 4 P.M. TO 7 P.M. MONDAY THRU FRIDAY. KEEP ROLLING FROM 9 TIL 2 AS THE JOLLY MILLER PRESENTS: THE GREAT MUSIC OF FreshStart MONDAY THRU SATURDAY. LIVE AND LIVELY.

**Double Bubble**

*The Jolly Miller Lounge*  
Monday to Saturday 11 a.m. til 2 a.m.  
Sundays noon til midnight

**Plymouth Hilton Inn**

5 MILE & NORTHVILLE ROADS  
call (313) 459-4500  
FOR MEETINGS AND BANQUET PLANNING

SERVING  
**PLYMOUTH-CANTON**  
COMPLETE OFFSET  
PRINTING SERVICE  
featuring  
3M  
412  
CAMERA  
Call  
453-6770



**The Pilgrim Printer**  
632 S. MAIN PLYMOUTH



# Area govt.'s prepare for tornado season

Tornado season is with us again and with it comes a concern about tornado protection in this community. The City of Plymouth and Townships of Canton and Plymouth all have tornado warning systems.

The City of Plymouth is in the process of revamping its "post-strike" plan.

"We don't have shelters and we don't have an evacuation plan - - we have a post-strike plan, which is very inadequate at this time and we are in the process of revising it," said Plymouth Police Chief Timothy Ford.

In the meantime, the City has

## Masons honored

A class of 423 Masons from 11 southeastern Michigan counties received Scottish Rite Freemasonry's 32nd degree at the conclusion of a two-weekend reunion on April 30 at the Detroit Masonic Temple.

Canton township Masons in the class were, Arthur H. Bellingham of 41497 Greenwood Dr., Donald D. McRoberts of 6878 Bunker Hill Lane, Cletis F. Sexton of 5634 Fordham Cir., and Duane G. Zantop of 44255 Dunchess Dr.

Warren R. Wright of 39711 Mayville, Plymouth was also a member of the class.

## Monaster tapped

The National Council of Teachers of English announced the appointment of Anthony Monaster, of the English Department at Canton High School, as a regional judge for the 1977 NCTE Achievement Awards in Writing Program. Through this nationally recognized competition, now in its twentieth year, approximately 800 high school seniors are cited for excellence in writing and are recommended to colleges and universities for admission and for financial aid, if needed. The NCTE also honors teachers and schools that have participated in the training of these young men and women. Eight thousand students have been nominated for NCTE Awards in 1977. Results of the contest are announced in October for each year.

a telephone-warning system. We have a fan-out phone system, which gives us information that we feed into a telephone warning system upon alert," said Ford. "This covers the entire school district area and it goes into schools and certain key industries during a tornado watch."

A tornado watch is that a tornado had been seen in the area, and for residents to keep a look out. A warning means a tornado has been sighted in the area and an alert means a tornado is imminent.

The Plymouth Township Fire Department has weather spotters and a plan for merging with the City in the event of a disaster.

"All of our people are trained by the U.S. Weather Service as weather spotters," said Town-

ship Fire Chief James Gignac. "Whenever we have a tornado watch we send a radio-equipped car to Ann Arbor Trail and Beck Rd., which is the highest point in the township.

"We merge with the City and take over Central Middle School along with the Plymouth Registered Nurses Association," added Gignac. "If the school should be destroyed, we move into the V.F.W. (Veterans of Foreign Wars) Hall on Mill St.

"We also have a radio hooked up with the U.S. Weather Service at Metro Airport and a call list that fans out so that each caller makes other calls."

Canton has plans for a siren warning system.

"We're in the process of asking for bids for two sirens, which

will be located at our new fire hall at Haggerty and Warren Roads and at the township offices at Sheldon and Geddes Roads," said Canton Fire Chief Mel Paulun.

"We already have a siren at our fire station at Cherry Hill and Canton Center. All three sirens will go off in the event of a tornado warning."

The Canton plan also includes county weather spotters and civilian recruitment.

"We just turned in a civil-defense plan to the county for their approval," said Paulun.

"They have informed us that in the event of a tornado they will send out weather-spotters to three locations: Napier and Ford Rds., Lilley and Ford Rds., and Denton and Geddes Rds."

"As it is now, we will use our civil defense plan even if it

doesn't get county approval," added Paulun.

"We are all set for our D.P.W. our fire, and police department.

"We are going to advertise for civilians to help with any type of disaster which may occur in Canton. The civilians will get civil defense training, including first-aid and C.P.R. training.



**PRINTING**  
**WHILE YOU WAIT**  
**IN PLYMOUTH**

**1170 W. Ann Arbor Rd.**  
Between Sheldon & Main

## I-275 to get traffic lights

The I-275 traffic lights are coming!

A spokesman from the Wayne County Road Commission has announced that traffic lights at the exit ramps from I-275 in Plymouth Township and Canton will be up soon.

Lights at Ann Arbor Road and I-275 exits will be up this month while the Ford Road and Michigan Avenue lights will be up this summer.

According to the county, the delay has been getting Detroit Edison to provide electric service to the sites.

**FRED'S CUSTOM BOAT**  
**REPAIRS**

Painting & Refinishing  
Wood - Fiberglass  
**CUSTOM ALTERATIONS**  
**QUALITY WORKMANSHIP**

26069 W. 8 Mile, W. of Beech 535-6750  
Open Daily 9-6 Sat. 9-1

*The Pool People...* **Viscount Pools**

3472 PLYMOUTH ROAD  
LIVONIA  
**261-7111**

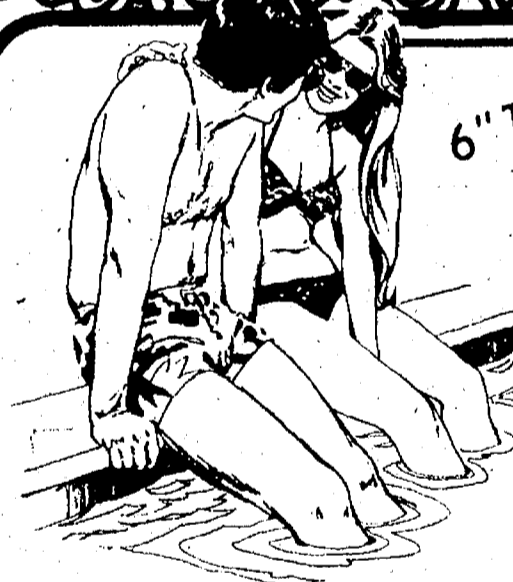

**COLECO GREENPORT**

18'x33'... **\$797<sup>00</sup>**

**6" Top Rail EXECUTIVE**

15'... **\$299** 18'... **\$319**  
21'... **\$349** 24'... **\$399**

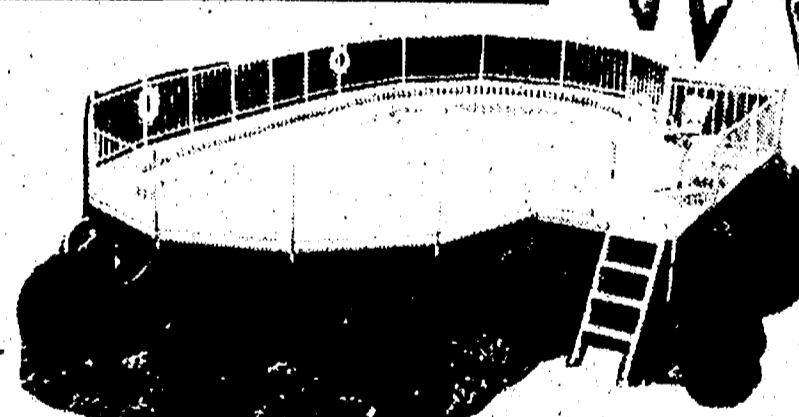

**ESTHER WILLIAMS MONTE CARLO**

12'x24'... **\$2395**  
15'x24'... **\$2849**  
15'x30'... **\$3149**

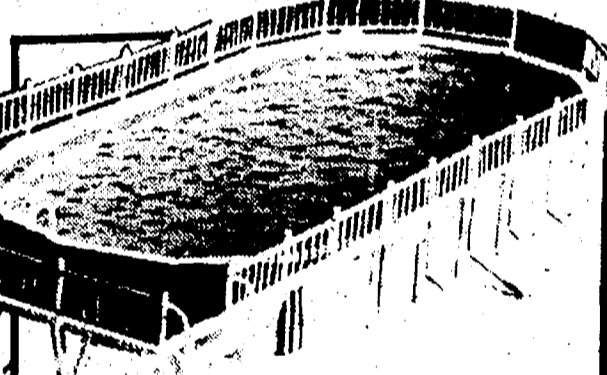

**ESTHER WILLIAMS MALIBU**

15'x24'... **\$2395**  
15'x30'... **\$2795**

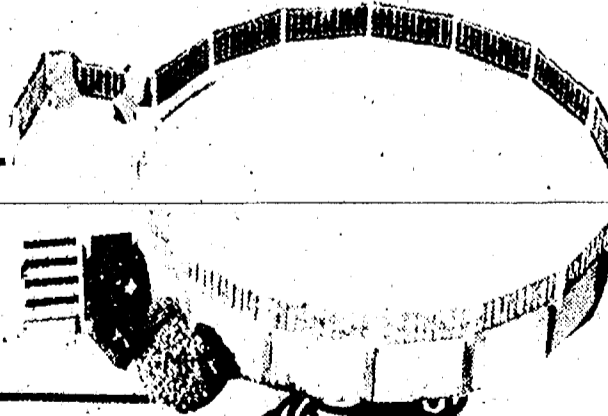

**ESTHER WILLIAMS CONCORD**

24'... **\$1995**

**NORTHVILLE**  
refrigeration service



**AIR**  
**CONDITIONING**

Sales Service Installation  
Central Systems Residential  
Commercial Industrial

**349-0880**  
18485 RIDGE RD.  
Northville

**Coupon Clipper Specials!!!**

20lb Pail <b>SUN</b> CONCENTRATE <b>\$38<sup>88</sup></b>	<b>\$10<sup>00</sup> off</b> any replacement <b>Liner</b>	Complete <b>Pool Pkg.</b> <b>\$99<sup>95</sup></b>	Liquid <b>Chlorine</b> <b>78¢</b> Gal.
--	---	--	--

# Schools announce this week's taste treats



## Lunch with LOMAS

Michigan Week will be here next week, and Fiegel Elementary is celebrating with a menu any state worth its beans and sugar would be proud of. For instance, 'Bad Axe Beans' on Tuesday (Aay - that's really tough, says the Fonzy) and 'Motor City Mashed Potatoes' on Wednesday. We used to dance to the Motor City Mashed potato. Remember?

Hulsing will have banana cupcakes next Tuesday -- time to go ape over those. A surprise lunch for Hulsing kids on Thursday, too.

Since Michigan is such a Water Wonderland, why not have lunch at the lake next week? Or better yet, bring your favorite lake to lunch at school next week. That's not such a bad idea when you consider it with a severe case of spring fever.

**ALLEN**  
Monday  
Chicken vegetable soup, peanut butter and jelly sandwich, fruit cup, dessert, milk  
Tuesday  
Spaghetti with meat sauce, bread cheese stick, vegetable, jello, milk  
Wednesday  
Turkey, gravy, mashed potatoes, home made hot roll, fruit cup, milk  
Thursday  
Hot dog on a bun with relishes, vegetable, fruit cup, dessert, milk  
Friday  
Cheese sandwich, vegetable, fruit cup, brownie, milk  
**BIRD**  
Monday  
Tomato soup, toasted cheese sandwich, tollhouse bar, fruit cup, milk  
Tuesday  
Taco with cheese, meat, pickles, green beans, fruit cup, milk  
Wednesday  
Cook's choice of meat, gravy with mashed potatoes, hot roll, fruit cup, milk  
Thursday  
Hot dog on a bun with relishes, vegetable, fruit cup, cake, milk  
Friday  
Fish sticks, french bread, vegetable chocolate pudding, milk  
**CENTRAL MIDDLE**  
Monday  
Hamburger on bun, french fries, fruit juice, cookie, milk  
Tuesday  
Submarine sandwich, potatoe stix cookie, fruit, milk  
Wednesday  
Pizza, vegetable juice, cookie, milk  
Thursday  
Open face turkey sandwich, mashed potatoes, gravy, peas, fruit cocktail cake and milk

Friday  
Grilled cheese, soup, jello salad, fruit bar, milk  
**ERIKSSON**  
Monday  
Chicken noodle soup, peanut butter & jelly sandwich, fruit, brownie milk  
Tuesday  
Ham on bun, relishes, vegetables apple crisp, milk  
Wednesday  
Pizza with meat and cheese, tossed salad, fruit, cookie, milk  
Thursday  
Hot dog on bun, relishes, vegetable fruit, cake and milk  
Friday  
Oven fried fish, vegetable, bread, butter, applesauce bar, milk  
**FARRAND**  
Monday  
Beef in gravy, mashed potatoes, bread and butter, green vegetable cake, fruit, milk  
Tuesday  
Spaghetti with meat sauce, cinnamon rolls, vegetable, fruit milk  
Wednesday  
Hot dog on bun with relishes, sauerkraut or green beans, cookie, fruit, milk  
Thursday  
Tacos, bread and butter, vegetable, cake fruit, milk  
Friday  
Fish sticks, vegetable, tartar sauce, chocolate cake, fruit milk  
**FIEGEL**  
Monday  
Government Day  
Tourist Center vegetable soup, Pinconning Grilled cheese, MacIntosh fruits and bar, Michigan Milk  
Tuesday  
World Trade Day

"Frank"-emuth on a buttered bun relishes, Bad Axe beans, Fort MacKinac Fruit and cookie, Michigan milk  
Wednesday  
Livelihood Day  
Michigan week hamburger, gravy, Motor City mashed potatoes, Sleeping Bear buttered warm roll, Michigan mixed fruit, Michigan Golden Spike, Michigan milk  
Thursday  
Education Day  
Benton Harbor beef-a-roni, Grayling vegetables, Apple Blossom fruit, Port Austin peanut cup, Michigan milk  
Friday  
Hospitality Day  
Peninsular Sloppy Joe on a bun, Petoskey Pickle slices, Superior vegetable, Fiegel fruit and cookie Michigan milk  
**FIELD**  
Monday  
Raviola with cheese, fruit, cottage cheese salad, bread, milk  
Tuesday  
Hamburger on bun, french fries, fruit, jello with topping, milk  
Wednesday  
Fish filet, cole slaw, fruit, cake, bread, milk  
Thursday  
Grilled cheese, tomato soup, crackers fruit and milk  
Friday  
Turkey with potatoes and gravy, vegetable, toll house bar, bread, milk  
**GALLIMORE**  
Monday  
Sloppy joes on bun, wax beans, fruit, cake, milk  
Tuesday  
Submarine sandwich, buttered carrots, fruit, cookie, milk  
Wednesday  
Fried chicken, mashed potatoes, gravy, french bread, jello, cake, milk  
Thursday  
Hot dog on bun, relishes, green beans applesauce, cake, milk  
Friday  
Fish patty on bun, corn, fruit brownie, milk  
**HULSING**  
Monday  
Grilled cheese sandwich or chicken salad sandwich, vegetables, chocolate chip cookie, milk  
Tuesday  
Ravioli with meat and cheese, garlic bread, green beans, banana cupcake milk  
Wednesday  
Oven baked fishburger, french fries, chilled peaches, peanut butter brownie, milk  
Thursday  
Lunch Surprise  
(to be outside if no rain)  
Friday  
Wiener and bun, oven baked fries, butterscotch pudding, fruit cocktail and milk  
**ISBISTER**  
Monday  
Sloppy joe, corn, peaches, chocolate cake and milk  
Tuesday  
Spaghetti with meat sauce, french bread, peas, apple strudel and milk

Wednesday  
Roast Beef, mashed potatoes with gravy, buttered roll, green beans, jello and milk  
Thursday  
Hot dog on bun, baked beans, fruit cocktail, cookie and milk  
Friday  
Fish patty, yellow wax beans, fruit cup, buttered bread, potato chips and milk  
**MILLER**  
Monday  
Hot beef and gravy over mashed potatoes, peach slices, rolls, milk  
Tuesday  
Hot dog on bun, relishes, pork & beans, cup of pears, toll house bar  
Wednesday  
Ravioli with meat sauce, tossed salad cup of fruit, cinnamon rolls  
Thursday  
Pizza Day  
Friday  
Grilled cheese sandwich, vegetable, fruit cup with whipped cream, chocolate chip cookie  
**SMITH**  
Monday  
Hamburger on bun, relishes, corn, peaches, cookie, milk  
Tuesday  
Bar-b-q on bun, tater tots, orange juice, cookie, milk  
Wednesday  
Pizza with meat and cheese, peas applesauce, cookie, milk  
Thursday  
Hot dog on bun, relishes, french fries, jello with fruit, cheese stix, cake and milk  
Friday  
Lasagna, bread, green beans, pineapple, milk, cookie  
**STARKWEATHER**  
Monday  
Peanut butter & jelly sandwich, chicken soup, fruit cup, cake, milk  
Tuesday  
Hamburger gravy over mashed potatoes, roll, jello, cookie, milk  
Wednesday  
Grilled cheese sandwich, green beans fruit cup, cookie, milk  
Thursday  
Turkey sandiwch, corn, fruit cup,

cookie, milk  
Friday  
Hot dog french fries, fruit cup, cookies, milk  
**TANGER**  
Monday  
Grilled cheese sandwich, pickle, vegetable, chilled apple sauce, cake, milk  
Tuesday  
Tacos with fixins, french fries, chilled mixed fruit, jello, milk  
Wednesday  
Salsbury steak and gravy over mashed potatoes, chilled peaches, bread stick cookie, milk  
Thursday  
Hot dog and beans, bread stick, chilled fruit, cake, milk  
Friday  
Pizza, chilled fruit, vegetable salad chocolate frosties, milk  
**MIDDLE - EAST**  
Monday  
Hot dog on bun, relishes, french fries, peaches, cookie, milk  
Tuesday  
Spaghettie with meat sauce, hot biscuit and butter, green beans, cake, milk  
Wednesday  
Turkey roll, mashed potatoes, gravy rolls, fruit cup, molasses cookie, milk  
Thursday  
Hamburger on bun, relishes, french fries, fruit, brownie bar, milk  
Friday  
Pizza with meat and cheese, green beans, apple crunch, milk  
**PIONER**  
Monday  
Chillburger on bun, relishes, hash brown potatoes, vegetable, fruit and milk  
Tuesday  
Spaghetti with meat sauce, roll, celery and carrot sticks, fruit or jello and milk  
Wednesday  
Hot turkey sandwich or hot beef sandwich, mashed potatoes, gravy, peas, carrots, fruit and milk  
Thursday  
Pizza with sausage and cheese, corn or salad, fruit, cookie and milk  
Friday  
Hot dog or fish on bun, relishes, bean soup with crackers, choice of fruit, cookie and milk  
**MIDDLE - WEST**  
Monday  
Hot dog, relishes, oen fries, choice of fruit, peanutbutter krinkles, milk  
Tuesday  
Spaghetti with meat, green beans, bread sticks, fruit, cake, milk  
Wednesday  
Turkey in gravy on mashed potatoes peas, roll, butter, strawberry jello milk  
Thursday  
Hamburger with relishes, oven fries orange juice, brownie and milk  
Friday  
Submarine sandwich, corn, applesauce, cookie milk  
**HIGH SCHOOLS**  
Monday  
Meat loaf, mashed potatoes, gravy, buttered vegetable, jello, milk  
Tuesday  
Hot dog on bun, chili, crackers, assorted fruit, milk  
Wednesday  
Tacos with fixins, orange juice, potato chips, dessert, milk  
Thursday  
Pizza, orange juice, vegetable, dessert and milk  
Friday  
Fish on bun, potatoes, vegetable, jello, milk

**No Lines.  
No Wait.  
No Big Check.**



**Thursday Family Day**  
\* 3 pieces chicken  
\* mashed potatoes and gravy  
\* Cole Slaw  
\* Hot Biscuits  
Reg. \$1.89  
now **\$1.49**

**Bucket**  
\* 15 pieces, gravy (pint)  
\* 6 Hot Biscuits  
**\$6.90**

**Barrel**  
\* 21 pieces of chicken  
**\$8.65**

**Grandma's Take Home Famous Recipe FRIED CHICKEN**  
Hours 11 am. to 9 p.m.  
1122 ANN ARBOR ROAD, Plymouth 453-6767  
(next to Beyer Drugs) Proprietor Joe LangKabal

**W-H-A-M-O-N-I-E**  
820 W  
Ann Arbor Tr  
Plymouth  
Mich. 48170  
453-8110

We have two new lines of lamps. Nice prices. Some are stoneware in soft earthy tones. Most spectacular is a brass ginger jar.  
For all you sailors who have started planning your summer entertaining, check out the Ingrid snack trays, glasses and mugs at Sideways. They nest well.  
**SEE YOU AT THE CIRCUS THIS WEEKEND!**

**sideways**  
605 FOREST  
453-8312  
PLYMOUTH MICH. 48170





**tell it to  
Phyllis**  
Call 453-6900  
Or write  
572 S. Harvey

Warm weather seems to bring out all sorts of things from freckles to mosquitos. The neighborhood kids look a lot taller, as you watch them jump over your newly planted flower garden. The grass in most front yards is beginning to turn green. Now if I could only figure out how to get rid of those darn ants and keep the bees away.

It's great to get out and see people again. Two happy, smiling faces in the Plymouth community belong to Milton and Roberta Orr, owners of Bill's Market on Starkweather. The Orr's celebrated 25 years with the market on May 1. When asked about their 25 years in business Mrs. Orr replied, "Plymouth is pretty wonderful, we're happy and thankful to still be in business here." The Orrs have many memories throughout the years and most have to do with children - "Since we don't have any children of our own, we love everyone else's children."

Our Lady of Good Counsel Church will honor the University of Detroit, now celebrating its 100th anniversary, and Fr. Alphonse E. Kuhn, S.J., who is marking his 43rd year with the University.

The twin celebration will occur at the parish's 12:30 p.m. Mass, next Sunday, May 15. Following the mass will be a reception in the parish hall.

Bruce Kirchoff, son of Mr. and Mrs. Kenneth Kirchoff of Brookside Dr., in Plymouth received his Masters Degree in Botany from the University of Michigan. He will be attending classes at the Biological Station at Douglass Lake, Michigan this summer, and plans to continue his studies next fall in the Ph.D. program at Duke University in Durham, North Carolina. While at U. of M., Bruce was an active member of the Rudolph Steiner Anthroposophical Society.

Ann W. Schaffer, daughter of Mr. and Mrs. George Schaffer of Mapletree Dr. in Plymouth is one of 37 Alma College students reliving the Civil War. During the four-week spring term they are concentrating their studies on the war between the states and the reconstruction period.

Alma College students from Plymouth who are among those named to the college's Term Honors List during the second term of the 1976-77 academic year are:

Sheryl J. Kirchoff, senior, daughter of Mr. and Mrs. Kenneth Kirchoff of Brookside, Dr;

Mark A. Turner, senior, son of Mr. and Mrs. Thomas Turner of Linden; and

Rita J. Walker, sophomore, daughter of Mr. and Mrs. Roscoe Walker of Crabtree Ct., in Plymouth.

A 65th floor room at Detroit's new Renaissance Center was the awesome setting for a reception for Susan and Scott Dodge of Plymouthites came throughout the day and enjoyed the Kentucky Derby among other things.

## Dems aid Stein defense

Canton Democrats raised money for their party and for Supervisor Harold Stein's possible recall defense at a dinner-dance in Westland Saturday

night. Proceeds from the affair will be split evenly between the Democratic Party of Canton and the successful November slate of

Supervisor Harold Stein, Treasurer Anne Bradley and Trustee Eugene Daley, according to Mrs. Bradley.

Mrs. Bradley said some of their share of the money would be used to defend Stein if a recall election is held.

Opponents of Stein are now 135 valid signatures shy of forcing the recall election.

The affair at the Wayne-Ford Civic League featured a champagne fountain, dinner, dancing door prizes and a floor show by the Betty and Bud Potts Troupe.

Approximately 300-400 people attended, Stein said.

## The Crier gets Canton legal notice contract

The Community Crier was awarded the publishing contract for Canton Township's legal notices and minutes last Tuesday by a 6-1 vote of the Canton Board of Trustees.

The Crier now publishes the legals for every government in the area it serves - - the Plymouth-Canton School District, the City of Plymouth, the Township of Plymouth and now Canton Township.

Clerk John Flodin cast the only "no" vote in the motion made by Treasurer Anne Bradley and supported by Trustee Lynne Goldsmith.

## Death seminar to be held

The Second Annual Symposium on Medicolegal Investigation of Death will be sponsored by the Wayne County Medical Examiner's Office and Wayne State University School of Medicine.

The symposium will take place on May 12 - 13, at the Hilton Inn, in Plymouth, Mi. Lectures and discussions will focus on:

Providing participants with a comprehensive overview of the technical and practical aspects of medicolegal investigation of death.

The program is intended for law enforcement officers, detectives, pathologists engaged in medicolegal work, coroners, traffic and arson investigators, and prosecuting attorneys.

**INSURANCE**



**FISHER  
WINGARD FORTNEY  
AGENCY, INC.**  
905 W. Ann Arbor Trail  
Plymouth, Mi \* 453-4990

## WSDP notes

On Wednesday, May 11, at 6:00 p.m., WSDP will present the second part of the Old Time Song Hit Parade with host Mel Guthrie.

# Springtime is ...



## Decorating Time

YOUR WHITE HOUSE DESERVES OLYMPIC.

Overcoat is specially made to go on over the old paint on your house. That makes it better than any ordinary white house paint you can buy!

**\$300 OFF**

Reg. \$12.95  
NOW **\$9.95**

**OLYMPIC OVERCOAT**  
OUTSIDE WHITE

**OLYMPIC STAIN**  
REDWOOD

OLYMPIC STAIN ENDS CRACKS CHIPS AND PEELS

REG. NOW  
\$10.95 \$7.95

(other colors available at reg. prices only)

**PEASE PAINT & WALLPAPER CO**  
570 MAIN STREET, PLYMOUTH  
453-5100  
New Summer Hours  
MON - FRI 8 A.M. - 9 P.M. SAT 8 A.M. - 6 P.M.

Your New or Present Automobile is a Large Investment & We're aware of that ...  
at

# MASTER-BRITE

We want You to be able To Enjoy That Investment Long after the Payments



Has the Finish lost its Lustre?  
a Coat of polish will bring it Back!

How much Road Grime is in Your Engine Compartment?

Does the Interior of your car Need Shampoo due to what the Winter Has Given us?

Faded Vinyl top or Carpet  
We'll RE-DYE it...

Car Dealers Call for Volume Rate

## Have it Done Right at Master Brite

534 FOREST AVENUE PLYMOUTH, MI. 455-8660

# Two-fisted politics comes to Canton

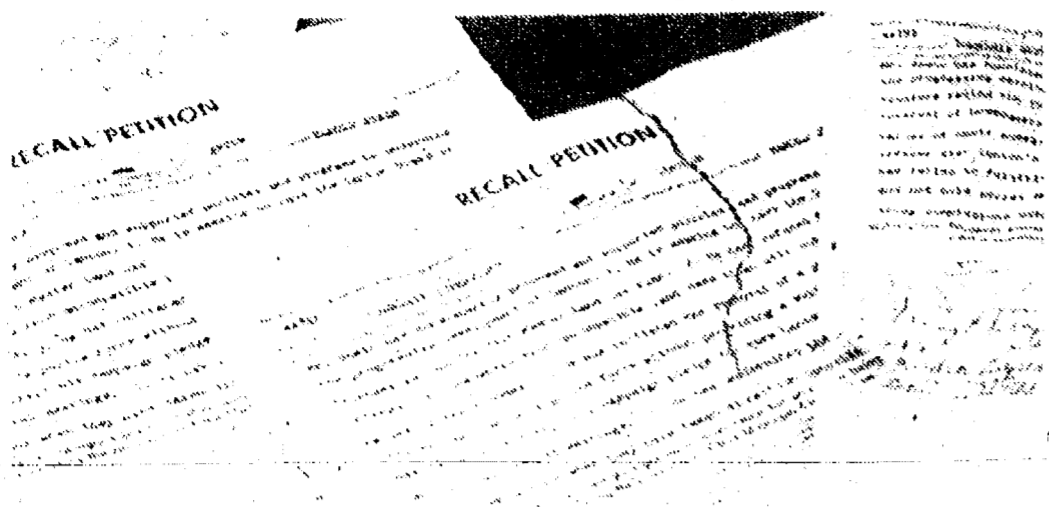

BY CHAS. CHILD  
Politics in Canton have been getting emotional - - but things really got out of hand Saturday, according to the Wayne County Sheriff.

Police said a man, apparently opposed to the recall of Supervisor Harold Stein, ripped up eight recall petitions and knocked down the woman who was circulating them.

Cindy Monks was circulating Stein recall petitions at the Rusty Nail Lounge, 43843 Ford Rd. in Canton, at 2:40 p.m. Saturday, the Sheriff's report says, adding that a Leonard Wasczenski approached Mrs. Monks and asked what the petitions were for.

Mrs. Monks told police she told Wasczenski about the petitions and that he then grabbed them and walked outside. Police reported that once outside, he ripped the petitions up.

The sheriff report says Mrs. Monks protested his defiling the petitions - - which contained 111 signatures, she said - - and then was knocked down by Wasczenski, a Westland resident.

No charges had formally been filed as of Monday.

Mrs. Monks told The Crier, "I have a fat bruise on my arm and one on my rear end."

She said 111 signatures were torn up. "I tried to tape the petitions back together," (Canton Clerk received the repaired petitions Monday afternoon.) Wasczenski could not be reached for comment.

## Briefcase Harvard Sq. organizes

The merchants at Harvard Square Shopping Center in Canton organized last Saturday night with the creation of the Harvard Square Merchants Association.

Officers for the new group are: Pat Breen, President; Les Campbell, Vice President; and Chuck Ferguson, Secretary-Treasurer.

Along with electing new officers, the group voted on a charter and made plans to meet once a month to work together on such projects as a sidewalk sale, a possible art show and various other promotions.

## Theiss appointed

William J. Thiess has been appointed manager of the Canton Township branch office of First Federal Savings of Detroit, it was announced recently by James A. Aliber, president.

He succeeds Ralph C. Brennecke, Jr. as manager of the Canton branch office, 41401 Ford Road. Brennecke has been appointed manager of the Westland branch office of First Federal Savings of Detroit.

Thiess was previously assistant manager of the Warren-Woodmont branch office of First Federal and has also served as assistant manager of the Livonia branch office of First Federal. He first joined First Federal in 1974.

## Correction

In last week's Briefcase on the first woman named to the First National Bank of Plymouth Board of Directors, Marian Kehrl's name was inadvertently misspelled.

## Community deaths

### Sumner

Walter Kellogg Sumner, 90, of 15070 Bradner, Plymouth Township, died May 8, in Wayne County General Hospital.

Funeral services were held in St. John's Episcopal Church with the Rev. Fr. Robert Shank officiating.

Mr. Sumner is survived by his wife, Ann; a son, John, of South Carolina; a daughter, Ann Wiloughby of St. Clair Shores, and seven grandchildren.

He was a manufacturer's representative, past secretary of the Michigan Manufacturers Assoc. a member of St. John's Episcopal Church, and a veteran infantry officer of World War I.

Sumner, a former member of Plymouth Township Board of Review for 10 years was the grandson of pioneer Plymouth landowner, John Kellogg. Sumner came to the Plymouth Community in 1940.

### Gilboe

Eleanore E. Gilboe of 7465 Sussex Drive, Canton, died May 1 in St. Mary Hospital, Livonia.

Funeral services were held in Schrader Funeral Home with the Pastor Frank B. Smith officiating. Burial was in Glen Eden Cemetery.

Mrs. Gilboe is survived by her spouse, Donald A. Gilboe; her daughter Mrs. Paul (Carol) Burrow, and grandson Donald and granddaughter Lynne Anne.

She was an office manager for the U.S. Government and moved to Plymouth from Livonia in 1972.

### Flanery

Mont Flanery, 73, of 2037 Marlowe in Canton died May 1 at St. Joseph Mercy Hospital in Ann Arbor.

Funeral services were held at the Schrader Funeral Home in Plymouth with the Brother Mason Howard officiating. Burial was in Knollwood Cemetery.

Mr. Flanery is survived by his wife, Frankie Flanery; daughter Mrs. Nancy Burks of Manchester, Tenn., stepson Robert J. Cleek of Plattsburg, Mo., sister, Idella Flanery and brothers George and Jessie Flanery all of Humphrey Co., Tenn.

He was a janitor at Burroughs Corp., in Plymouth and affiliated with the Church of God and Mountain Assembly in Ypsilanti.

### Maloney

Mary A. Maloney, 76, of 4476 March Trail, Plymouth, died May 5, in St. Mary Hospital, Livonia. Funeral services were held at Our Lady of Good Counsel Catholic Church with the Rev. Fr. Francis Byrne officiating. Arrangements were made by the Lambert Funeral Home. Burial was in the Holy Cross Cemetery, Detroit.

Mrs. Maloney is survived by daughters Patricia Stone of Plymouth and Mary Lou Stewart of Warren; sisters Leona Wyatt Dora Ross and Ann Kaiser; and five grandchildren.

She was a member of the Our Lady of Good Counsel Rosary and Altar Society.

DO NOT FOLD, SPINDLE OR MUTILATE. Ripped, but repaired petitions asking for Canton Supervisor Harold Stein's recall lie in township offices Monday, waiting to be received by Clerk John Flodin. The petitions were torn up in an incident at the Rusty Nail Lounge Saturday afternoon. (Crier photo by Chas. Child.)

*Allen Monuments & Vaults*  
580 South Main St. Northville, Mich. 48167  
Phone 349-0770

Fred Schrader's horse drawn hearse, Circa 1904.

The **SCHRADER** family  
FUNERAL DIRECTORS IN PLYMOUTH  
SINCE 1904

*A Tradition Dedicated to Service*

For three generations the Schrader family has strived daily to provide the highest degree of thoughtful, considerate and personal service.

280 SOUTH MAIN STREET  
PLYMOUTH 453-3333

## CEP to ban junk food

BY SUSAN NICHOLAS

Food, junk or otherwise, has been having an impact at the CEP of late.

At Canton, about 10 students have been involved in an independent study project on nutrition sponsored by English teacher Barbara Masters.

As part of their project, the students have been doing research on nutrition, visiting other schools, and holding events like a recent four-day lunch check.

The aim of the lunch check was to see if Canton was meeting the minimum federal requirements on nutrition.

Canton was meeting the federal requirements "in some areas but not in other," said Canton principal Kent Buikema.

But, Ms. Masters says the results of the check are not final.

"There's a lot more research that has to be done on that," said Ms. Masters.

At the end of this month the students will attend public hearings in East Lansing on State Bill 454, which concerns the state school lunch program.

A meeting the students held with Buikema, school finance director Daniel White, assistant business superintendent Ray Hoedel, and parents also tackled the food issue.

"One of the things we looked

Cont. on pg. 17



# Glimpse at yesterday



THIS WEEK'S "Glimpse at Yesterday" provides the solution to a mystery raised by Tivadar Balogh. He wrote The Crier (and supplied the photo) to say, "There is something about the main facade of the Masonic Temple that has generated hours of argument and discussion among the Kellogg Park Wet Backs."

(The Wet Backs are known by that name for the frequent drenching they have received while lunching in the park and being caught unawares when the city turns its sprinklers on.)

"I think the noble Crier could indeed help solve the mystery by conducting a survey of its readers as to why the elevation of the temple is as it is," Balogh continued. "I enclose a photograph taken at 12:32 p.m. after a normal park lunch session complete with discussion and debate in all manner of esoterica, including the Masonic Temple facade.

"The question is: were the pair of brick panelled areas (complete with stone sills) on the left side of the second floor built that way originally - or were they built as windows, which have since been filled to appear as they do now?"

"You must admit that the clarity of architectural history is in the balance here. There must be someone in the community who has the answer," Balogh concluded finally.

Since it is one of a newspaper's responsibilities to solve issues of the day, The Crier has already taken steps to solve this "mystery."

Fred Hadley, who is a member of the Masonic Temple's building committee, said the temple was built with the windows bricked in because of a change in the original plans to put a stairwell by those windows.

## Canton trustees vote to buy park land

The Canton Board of Trustees voted to purchase 28 acres at the southeast corner of Saltz and Morton-Taylor Rds. for a park last Tuesday. The land will cost the township approximately \$130,000.

Clerk John Flodin said Detroit Edison, the current owners, preferred to sell to the township rather than a house developer, for public relations reasons.

The vote was 6-1, with Trustee Robert Myers voting "no."

Baseball diamonds and swings were discussed by the board for the new park, recommended by Canton's recreation development plan issued in March.

Tom Quinn, president of the Camelot-Parkwood-Westbrook Homeowners Assoc., polled his group and found 82 per cent favored the purchase of the park abutting their subdivisions.

When the land was first proposed as a park last year, there were complaints by local homeowners that the park would lure "rowdy" youngsters, and the electric lines running through the land were dangerous.

## Tuition raised

Summer school tuition rates were raised Monday by a unanimous vote (with Member George Lawton absent) of the Plymouth-Canton School Board.

Fees for the program, which is supposed to be self sufficient, were hiked from \$24 per half academic credit to \$30 and from \$12 per non credit to \$20.

Summer School Coordinator Fred Meier said most of the cost increase was necessary to meet teacher-contract obligations.

## School athletics

Cont. from pg. 3  
continuing athletics in the school."

At the end of his presentation, Sinclair asked the Board to be allowed to sit down and discuss the proposal with Sandmann.

During his report, Sandmann indicated that the schools had responded favorably to keeping seventh and eighth grade athletics,

"No matter which way this (matter) goes," said Sandmann, "we will both continue to meet and exchange ideas. Our relationship (PCJAA and schools) is on the highest level."

## CEP food

Cont. from pg. 16

at was (1) identical menus - regular and a la carte - in both lunch lines and (2) a greater variety and better appearing food," said Hoedel.

Another thing that was brought up was the lack of a food service director in the schools," said Hoedel. "There is a need for that position in the schools and, hopefully, I can get board approval of that so I can hire the person by Fall."

Presently, the CEP does not have a dietician, said Hoedel.

At the same meeting, junk food was dealt a blow with Buikema's announcement that come Fall, both Canton and Salem will get rid of their vending machines.

"It is our intention to remove them in the Fall because of junk food and the mess that they create," said Buikema.

Right now, Canton has three vending machines: one for beverages, one for junk food, and one for nutritional foods like granola bars, said Buikema. Salem principal Bill Brown said that Salem's school set-up was larger but similar.

## FLOWERS by Margie Rae

Beautiful Floral Arrangements  
for all Occasions.



**PROM CORSAGES:**  
SWEETHEART ROSE \$4.50  
CARNATIONS \$3.00  
BOUTONNIER \$1.25

in the Harvard Square Shopping Center Ford at Sheldon **455-3300**

Complete wedding, prom, gift, and funeral services

We have the Best Prices on  
**LIQUID PROTEIN**

Herbs & Spices • Natural Grains and Nuts  
Dannon Yogurt • Minerals • Meatless Foods  
Diet Foods • Vitamins • Pure Juices  
Natural Snacks • Allergy Foods • Ginseng  
Natural Ice Cream and much, much more!

"the natural place to shop"

**10% OFF ON ALL PRODUCTS**  
WITH THIS AD

**friends of nature** health food center  
5924 Harvard Square  
Ford Rd. & Sheldon 455-5550

## WHAT IS THE GOURMET STEAMER?

It's an exciting new alternative to the humdrum traditional methods of cooking. By steaming foods you not only retain the natural flavor, but also preserve the essential vitamins and minerals.

### HOW DOES IT WORK?

- Place food in steamer. No need to add water to steamer but do include some of your favorite seasonings or herbs.
- The steam will rise through the center and gently but thoroughly cook your food.
- The attractive handmade steamer also doubles as a serving piece, since it can go directly from saucepan to table.



ALSO GREAT FOR GIFT GIVING!

**The Jig Tree**

OPEN THURS.-FRI.-SAT. TIL 9  
**459-5750**

**GIFTS -N- THINGS**

Sheldon Rd. at Ford Rd. in Harvard Square Center

## Interior Reflection

● **SALE UP TO 35% OFF WALLPAPER**

SUNWORTHY, BOLTA, ASTOR, SOME SCHUMACHER

● **SALE 20% OFF Custom Draperies & Bedspreads**

● PAPER HANGING/PAINTER SERVICE ● DECORATING CONSULTATION

5948 Sheldon Road

Harvard Square Shopping Center

Located at Ford & Sheldon Roads in Canton

**SHOP AT HOME 459-0100**

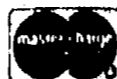

# Miller Woods: Nature on an intimate scale



A spring flower adorning the forest floor.

## Flowers, Fungi, and Foliage

With no grand mountain vistas or valleys, nature in southern Michigan is better seen on a smaller scale - a spread of white trillium, a pheasant call in the distance, or shelf fungus on a rotting log.

All these were part of a nature walk through Miller Woods given Saturday by a group of people interested in keeping the small forest unspoiled.

The Committee to Save Miller Woods includes Penny Wright, Pat Atchinson, Herb Conant, and Evelyn and William Edgar.

The approximately 15 acres on Powell Rd. in Plymouth Township is owned by the Plymouth-Canton School District. The

federal department of Housing and Urban Development provided the funds to buy it and stipulated that the parcel remain undeveloped.

"The woods won't be cut," said Evelyn Edgar. "We are interested in keeping it clean. A clean-up drive last month netted two refrigerators and a davenport among other things."

Evelyn and her husband, William, led the tours Saturday, pointing out the large variety of shrubs, flowers, fungi, ground cover and trees in the Beech-Maple climax forest. A climax forest is the fully mature one for any given climate, taking hundreds of years to form.



A trio of flower stalks catches the morning sunlight.

**"A clean-up  
netted two  
refrigerators and  
a davenport"**



Guide Jim Friedlander points to the tree-tops during his commentary on wild-life in Miller Woods.



An example of the unsightly litter Miller Woods devotee's must contend with.

*Story and photos by*

*Chas Child and Jim Merriman*

## 45-15 calendar decision soon

A decision on which 45-15 calendar will be used in the future will be made soon.

The Plymouth-Canton School Board received a Calendar Committee update at its regular Monday night meeting.

The Calendar Committee presented information to the board that included its computer research and findings, and recommended three school calendars.

A public hearing is scheduled for the 45-15 recommendations for Monday, May 16. Following

the hearing the board is expected to adopt a calendar for the 1977-78 school year at its regular May 23 meeting.

The calendars recommended by the Committee were Calendar A, recommending a traditional school year; Calendar B, recommending a 45-15 Block Start; and a suggested 45-15 Block Start, Calendar C.

The Committee presented strengths and weaknesses of the calendars B and C. Calendar

B will block start students on tracks A, B and C; Calendar C will block start students on A, B and D tracks.

On Calendar B, the D track will start four weeks later than the three block start tracks. On Calendar C, the C track will start four weeks later.

Trustee Tom Yack asked if more changes would be made

on the calendars before the scheduled May 16 workshop.

"That will be up to the negotiating teams," said Sam Ul-saker, Administrative Asst., for Research at the schools. "In all fairness, they were not privy to information at workshops - we will make the information available to them so they can make the best decision."

The schools to be affected by 45-15 next school year will be Gallimore, Isbister, Eriksson, Field and Miller.



# CEP study asks for modular change

Revision of modular scheduling, adoption of stricter attendance policies and the formation of an alternative high school are among the initial recommendations made by a Centennial Educational Park Study Committee.

The study group, which has been investigating the program at Salem and Canton High Schools for the past month, made its first suggestions to the Plymouth-Canton Board Monday.

The report urges a less broad use of the controversial modular scheduling for ninth and 10th graders and a more structured use of "free time" under the schedule.

Members of the committee termed the report's suggestions a "compromise".

"I personally would like to see more forceful measures," said School Board Member Richard Arlen, who was a member of the committee. But, he added, he supported the report because "it's moving in the right direction."

Marcia Borowski, the other school board member who served on the study group, said the report was only "preliminary" and that the on-going committee would get more points worked out in the future.

The school board voted unanimously Monday (Member George Lawton was absent) to begin implementing the study group's recommendations and to form another group to study plans for an alternative high school.

"The important things is that we're going to keep working with this (CEP study)," Arlen said.

The committee's report is as follows:

## I. RECOMMENDATIONS FOR THE 1977-78 SCHOOL YEAR

### A. Scheduling:

1. Ninth and tenth graders would be able to earn the privilege of going on modular scheduling based on the following criteria: a. Parental permission on a signed note. b. Minimum grade point average of 2.5 or no failing grades. c. No apparent attendance or disciplinary problems as attested to by coordinators and/or counselors. d. If feasible for this particular

year, the signed permission of no less than four teachers who feel the student can, in fact, handle modular scheduling. e. Exceptions may be considered by the administration.

2. For all students placed on modular scheduling, grades 9-12 unscheduled time is to be handled as follows: a. For those students whose counselors so indicate, a weekly STP schedule is to be filled out and basically adhered to. b. For the remaining students who need more structure and accountability, the student will be scheduled into a specific room for each mod of the day. The person responsible for that room will have a class list and will take

attendance, and report that attendance to the proper school administrator.

3. All modular classes will be required to meet no less than 12 mods out of the 18 mods (four hours out of six) during each cycle. If possible, each class should meet for 14 mods per cycle. These mods would have to be in a class situation: large group, small group, lab, under the supervision of a teacher. This would not include any mods spent in resource centers, labs, etc., during which the students were not under the supervision of their classroom teacher.

4. Ninth and 10th grade students who demonstrate that they cannot handle modular scheduling will be placed on a more traditional scheduling as soon as feasible.

5. A more strict attendance policy with stiff penalties will be developed for 1977-78.

6. The committee urges that sufficient additional personnel be hired to implement adequately the program for the school year, 1977-78.

7. Specific procedures to implement the above recommendations will be formulated by the CEP administration.

B. The School Board should

consider strongly the establishment of an alternative school (150-200 students) for the 1977-78 school year.

## II. GENERAL RECOMMENDATIONS

A. There should be a schedule of regular, frequent meetings between the high school and middle school staffs for better articulation. Counselors and teachers in the middle schools must be more familiar with the CEP programs.

B. Articulation of curriculum for both levels is crucial. This should be one of the first priorities for the Curriculum Dir.

## III. ON-GOING CEP STUDY COMMITTEE FUNCTIONS

A. A middle school representative should be included on this committee for all future planning.

B. Continuing evaluation by the Study Committee should be conducted so as to improve the program for 1978-79.

C. This committee should continue to function and consider additional concerns in the CEP program.

Members of the CEP Study Group were: Richard Arlen, Marcia Borowski, Bill Brown, Kent Buikema, Scott Beaman, Dallas Goss, Fred Libbing, Marian West.

## Schools set schedule

Whether or not there's a formal meeting Plymouth-Canton School Board meeting scheduled, the board will meet each Monday night except holidays.

On Monday's when a regular or special school board meeting is not held, the board will meet at 7:30 p.m. at the school district offices, 454 S. Harvey St., for a workshop session.

The public may attend all school board meetings - - held at Canton High School - - and workshop sessions.

## Recreational Vehicle Life

by Earl Rafferty



Outfitting a camping tool kit is not the same as equipping a workshop at home. Carrying capacity is limited, and the tools are heavy. Indiscriminate tool toting can add hundreds of pounds of hidden weight. So selecting a camper's tool kit calls for making some hard decisions. Remember that all the tools together must be reasonably light. They must have a realistic probability of being used. They should be capable of doing more than just one job, where that is practical.

Whatever kind of travel trailer you want, from the smallest to the largest unit, can be found with a visit to us at WALKER-RAFFERTY CO., 25431 Michigan Ave., 562-7661. We have many previously owned units in both motor homes and travel trailers. Come in and look them over, and remember we take trades of a trailer, car, truck or anything else of value.

Emergency-only tools should not take precedence over the mundane ones like a good tire gauge, a wrench for the pressure cap on the water system, etc.

Put more summer in your life

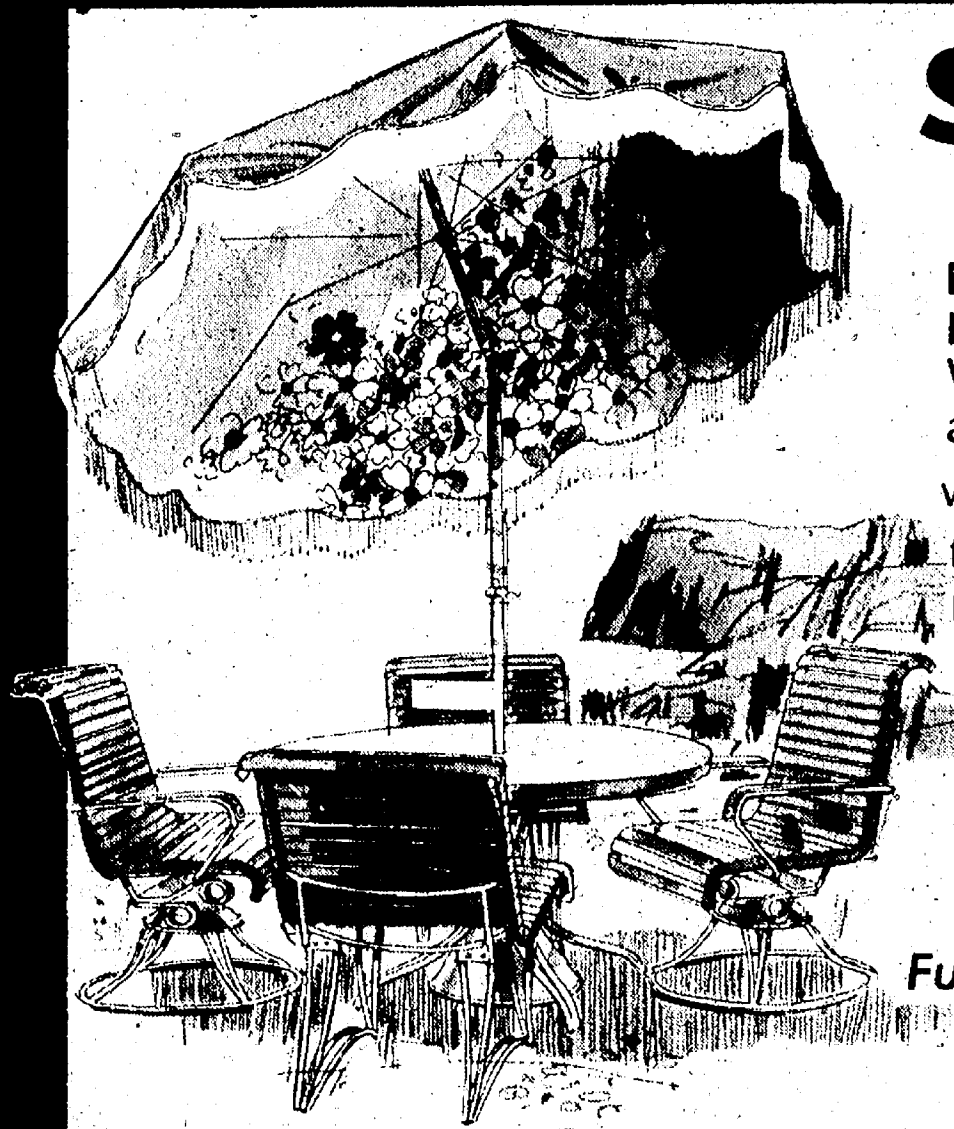

SAVE \$64<sup>00</sup>

Enjoy those soft summer breezes with Homecrest's Sacramento Set. Welded steel frames are plastic coated, and combined with vinyl straps for all-weather durability. Table top is molded fiberglass with a textured finish. Umbrella is optional.

We have the Areas Largest Selection of Quality Casual Furniture, offered by Nationally Known Manufacturers for the Discriminating Shopper

\*Rattan\*Wicker\*Redwood\*Wrought Iron\*Aluminum\*Strap \*Director Chairs\*Umbrellas\*Barbeques  
\*Hamocks\*Brown Jordan\*Samsonite\*Meadowcraft\*Gold Medal\*John Hancock \*California Umbrella  
\*Homecrest\*Vogue\*Calif. Asia\*Lloyd



3500 Pontiac Trail, 662-3117

New Hours: M,W,F 10-9; T,T,Sat 10-6; Sun 11-5

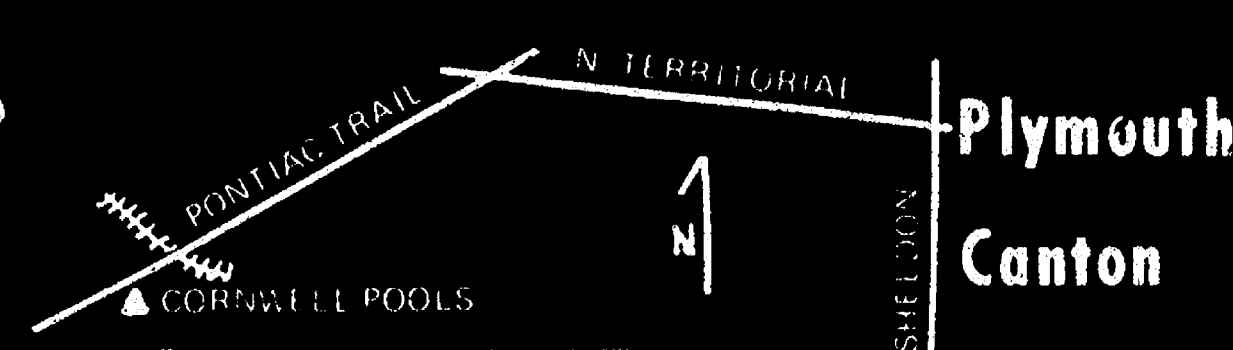

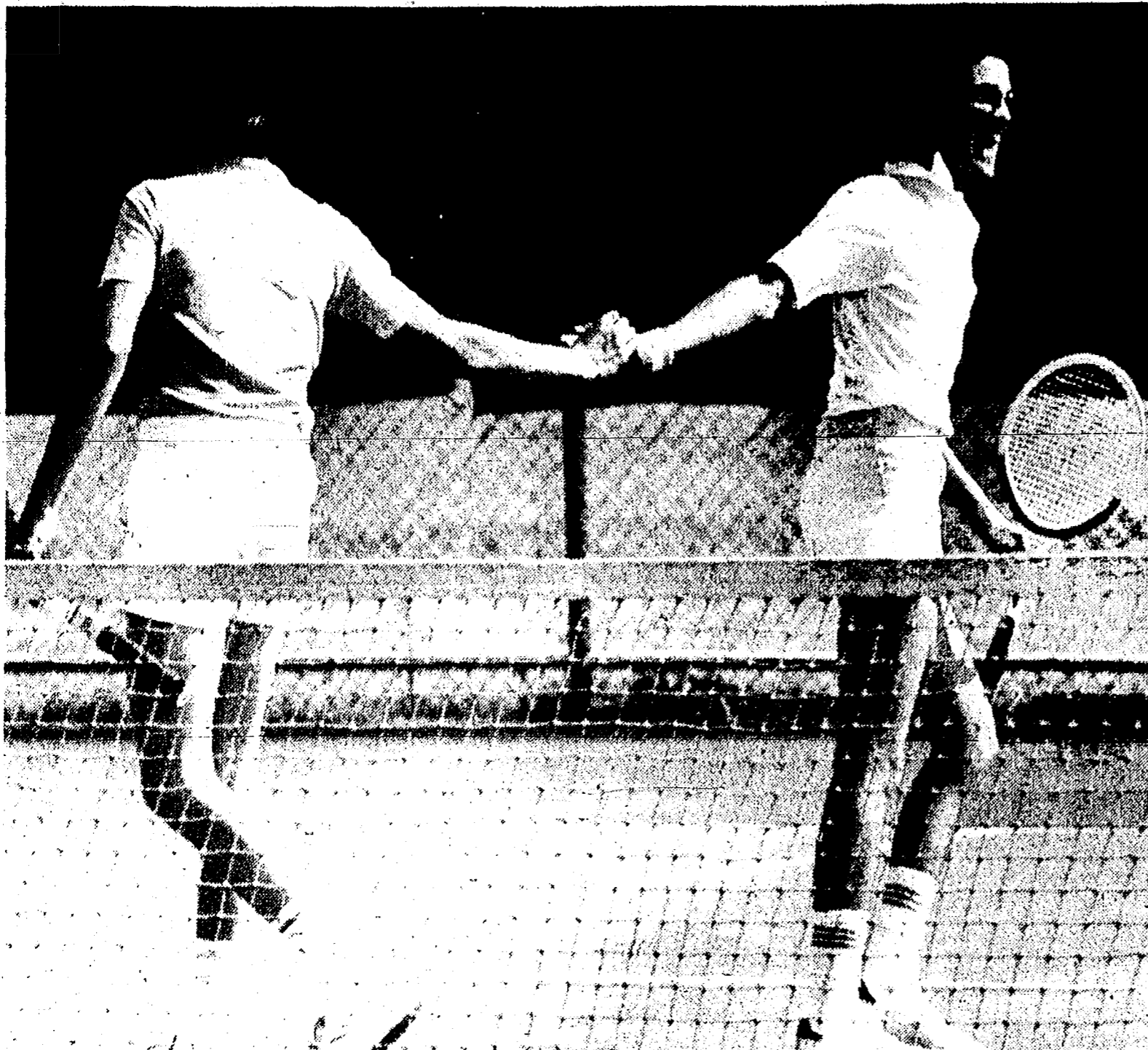

THE UNDEFEATED SECOND DOUBLES TEAM on the Rock tennis squad, Craig Stevens (left) and Ed Thomas congratulate one another and go separate ways after winning yet another match from Bentley last Thursday. (Crier photo by Susan Sheiner.)

ther and go separate ways after winning yet another match from Bentley last Thursday. (Crier photo by Susan Sheiner.)

# the Crier Sports

## Sub-8 foe A. Park buzzes Salem bats

BY DONNA LOMAS

The Salem baseball squad lost a Suburban Eight game to Allen Park Tuesday night, 6-4.

Allen Park put the game away in the fifth inning with two hits. Salem scored one run in the third, two in the fourth and one in the seventh.

Ben Wilcox hit two singles, and went two for three during the game. Bob Waite hit a triple, one RBI and two hits. Pitcher Tom Chiatialis took the loss, pitching the first three and one-third innings, and Doug Holloway took the rest.

Salem baseball coach Brian Gilles took the loss in stride.

"We expected to have a battle with them," he said. The Rocks meet Belleville this Friday and go into a doubleheader with Wayne Saturday.

## Salem, Canton golfers

### break school records

The Salem golfers defeated Canton in a match at Hilltop Golf Course late Tuesday afternoon, 208-228. It was a new school record for both teams.

Winner for the day was Canton golfer Cathy Anderson with a 49. Salem scorers were Betty Delano and Laurie Erikson with 51; Anne Arthur with 52 and Joanne Szilagyi with 54. For Canton, Charlene Rodden shot a 57, Peg Visser shot a 59 and Lynne McAllister shot a 63.

## Canton netters blast W. Lake

The Canton tennis team won a Tuesday match with Walled Lake Western Tuesday 5-2. The Chiefs league standing is now 3-3.

First singles Steve Paisley took a win, as did second singles, Dave Keen and Chris Davio in fourth singles. Second doubles combination of Paul Ardanowski and Doug Hetu and third doubles of Stuart Sobczynski and Matt Norris also had wins.

## Rocks sweep triangular

The Salem girls track team took a triangular meet win over Ladywood and Thurston high schools yesterday afternoon, 63-48½-32½.

They meet Sub Eight foe Allen Park Thursday. Triple winner Joanne Langkabel took first place in the hurdles in :16.9, she was also part of the 880 relay team who took first place in 1:53.2, the team's best time so far. Also on the 880 were Cindi Levielle, Sue Jenkins and Polly Richards.

The mile relay won in 4:28 with Langkabel, Cathy Velkie, Jenkins and Levielle.

Julie Prehlik was a double winner in the shotput and discus, hurling respective distances of 28'10" and 86'9". Kathy Sample took first in the mile in 5:51. It was the first time she ran the mile.

Second place wins went to frosh Zilkie in the 880 yard in :35.9; Kim Brown placed third in the 880 in :36.9, "one of the better performances of the day," said Kurtz.

## Canton Lift-a-Thon scheduled

The Canton High School Lift-a-Thon, a fund raiser to buy equipment for the CEP Phase III weight room, is scheduled for next Thursday, May 19.

The Red Chapter of the Plymouth Boosters Club is sponsoring the weight-lifting activity

during which contestants will test their strength on the leg press, bench press, and military press. Pledges will be collected on the total amount of weight lifted in the three exercises.

Canton Lift-a-Thon organizer and football coach, Dave Schuele said the equipment room needs about \$3,000 in addition to what has already been purchased by the schools.

All Canton High School boys are eligible for the Lift-a-Thon and will be placed in one of four categories for competition, (lightweight, middleweight, light heavyweight and heavyweight) Prizes will be awarded in all categories.

A Hustle Award will be given to the student that collects the most money. You can pick up your pledge sheets in the Canton General Office.

## Bike Day this Saturday

The first of three scheduled Bike Days on Hines Park will be this Saturday, May 14.

An 11 and a half mile stretch of Hines Park will be closed so that bike enthusiasts can enjoy the park.

**Little Caesar's**  
**Family Inn**  
PLYMOUTH  
1492 SHELDON RD. at Ann Arbor Rd.

# PIZZA

- \*Original round
- \*Crispy Gourmet Square
- \*Deep Pan

So good you'll eat your fingers off!!

## SPAGHETTI

**1.99 ALL YOU CAN EAT 1.99**

LITTLE CAESAR'S SPECIAL

our famous SERVED MON., TUES., and WED Crisp tossed Garlic Bread 4 P.M. - 9 P.M. ONLY

A GENEROUS PORTION OF SPAGHETTI

with your choice of two great gourmet sauces,

99 cents children under 12 yrs. - does not include salad

## BEER WINE COCKTAILS

**CHILDRENS BIRTHDAY PARTIES**

**FREE MINI-PIZZA HATS & GAMES**  
Cartoons Old Movies

For Carry Out Service Call

**453-1000**

**FREE!**

See your TV Guide for Free Pizza Coupon



# Chief thinclads lose meets, frosh set records

BY MATT NORRIS

Canton boys track team dropped two meets last week to Redford Union and Waterford Mott. The runne s also competed in the Redford Union Relays Saturday, breaking one school record. The team is now 0-2 in the Wes-

tern Six and winless in four tries overall.

The Chiefs lost to Redford Union on the Canton track Tuesday, 124-33. "We were overwhelmed, and they handled us easily," said Canton coach Mike

Spitz.

Bill Murphy and Rick Fleischer were the only Canton thinclads to take firsts against Redford Union. Murphy won the two-mile in 10:19, and Fleischer won the 440 yard race in :54.9 seconds. Murphy also took second in the mile in 4:55.8. Greg Kregoski and Andy Lewis took the only other second places for Canton, in the 220 and discus events.

Canton dropped a league dual meet to Waterford last Thursday, by a 131-26 margin. The Chiefs had only two firsts, two seconds, and two thirds in the drubbing.

Murphy won the 880 in 2:10.3 and the mile relay team won the other first place in 3:45.4. The team of Cliff Norris, Dan McGlenn, Fleischer and Murphy was the first relay victory for the team this year.

Martin Hinckley was second in the 330 yard low hurdles with a time of 44 seconds, and Randy Reinas-leapt 5'8" in the high jump, also a second place. Hinckley's time set a school record for the low hurdles, and Lewis set a new mark of 40'9" for the shotput. Lewis also took third in the discus, and Hinckley came in third in the 440.

The sprint medley team of Mike Mowry, Dan Cronin, Murphy and Norris broke the old record by seven seconds at the Redford Union relays Saturday. The team raced to a 2:38.5 mark.

Four freshman records were set in dual meets last week, in the half mile, mile, two mile, and 330 low hurdles. Brian Olk set the record in the half mile, and it was Phil Simon in the mile, David Spitz in the two mile, and Greg Schevshik in the hurdles.

## Chiefs chalk up 19th

BY CRAIG BRASS

The Canton Chiefs won their 19th game in a row Monday as senior hurler Mark Perkins went nine innings to defeat Walled Lake Western 5-4 in two extra stanzas.

Perkins notched up his fifth victory of the season as Canton raised its league mark to 3-0 and overall record to 12-1.

The Chiefs were ahead two zip going into the third but, without collecting a hit, Western tied the game at 2-2. The Warriors picked up one in the fourth and in the fifth to go ahead of the Chiefs 4-2 as the Canton batsmen were caught sitting on their lead. Trying to shake things up, Coach Fred Crissey benched one of his starters Steve Mormon for "lack of enthusiasm" on the field.

The score remained at that point until the bottom of the seventh when Kevin Randazzo scored as senior Mark Zydeck singled to center with two outs bringing Razz home and sending Rob Mandle to third. Zydeck then forced the Warrior pitcher to balk when he walked off first base. This sent Mandle home with the tying run and the Chiefs had rescued themselves from another jam. John Young ended the inning grounding out to third.

The Chiefs rejected two attacks in the eighth and ninth and went on to win in the bottom of the ninth. Senior Ken Britton drew a walk and advanced to second on Scott Collins' single. Mandle then came to the plate with one out and bounced a double play ball to third. Taking the ball on one hop, the Western third bagger threw into rightfield allowing Britton to score the winning run.

The Chiefs collected eight hits, Collins picking up three of those, as the Chiefs stayed perfect and in first place in the Western Six competition.

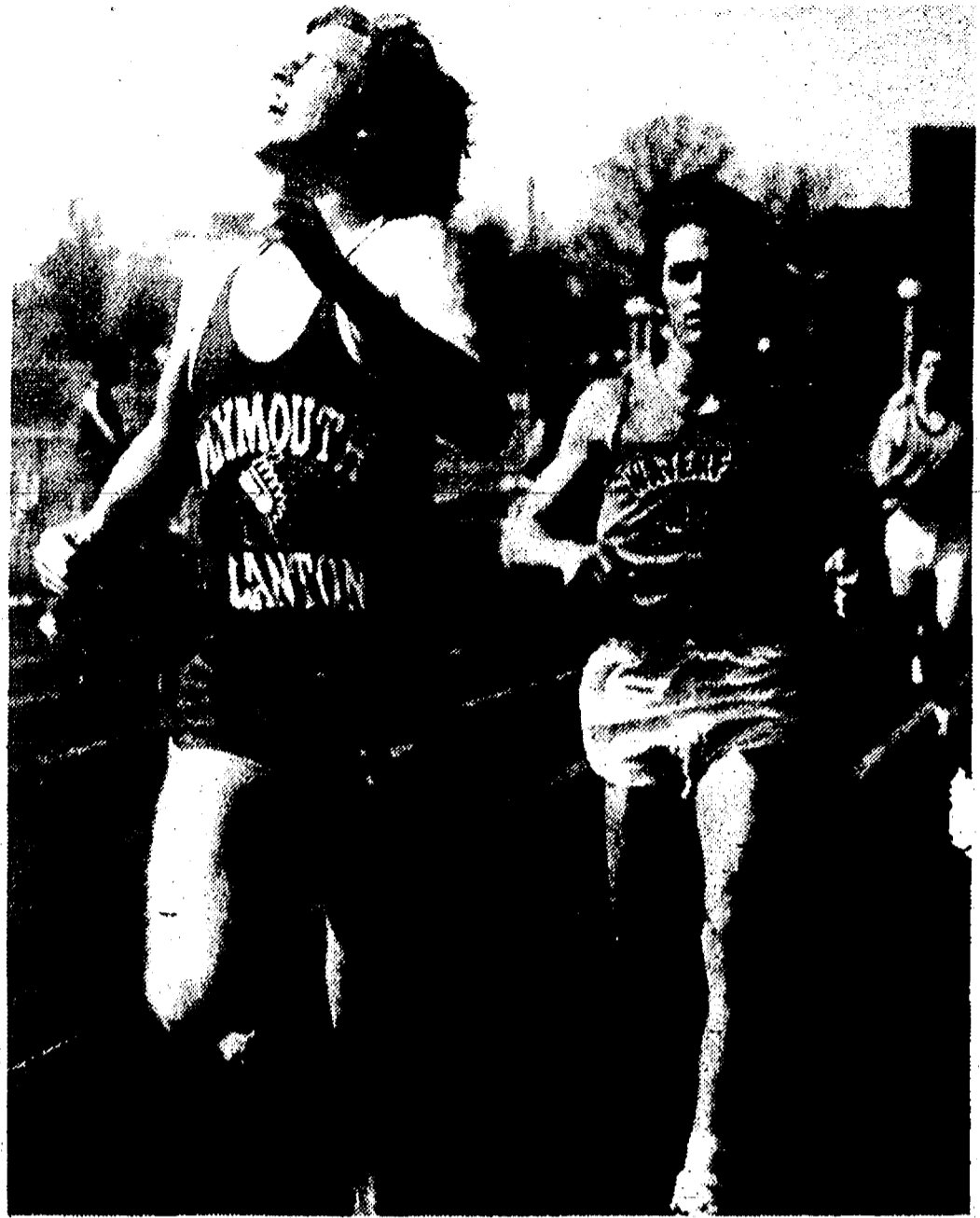

CANTON THINCLAD Bill Murphy took first place in the 880 run last week in the meet with Waterford Mott. (Crier-photo by Susan Sheiner)

# SALE

**1/2 PRICE ON CRABGRASS CONTROLS**

**STOCK UP NOW FOR NEXT SEASON!**

No.1 Potted Non-Patent  **\$4.25**  
ROSES Patents \$4.95 & \$5.95

**GERANIUMS..... 99¢**

**Packaged & Potted Perennials...**

- |                           |            |                           |
|---------------------------|------------|---------------------------|
| PACHYSANDRA- Ground Cover | AJUGA      | DICENTRA (Bleeding Heart) |
| PRIMULA                   | ARTEMESIA  | HARDY PHLOX               |
| SEDUM                     | ASTER      | PEONIES                   |
| SEMPERVIVUM               | ASTILBE    | GEUM                      |
| Hen & Chick               | CAMPANULA  | GYPSOPHILIA               |
| VERONICA                  | CARNATIONS | LAMIUM- Ground Cover      |
| VINCA MINOR               |            | LILY OF THE VALLEY        |
| FUNKIA                    |            |                           |
| MUMS                      |            |                           |
| SHASTA DAISY              |            |                           |
| DELPHINIUM                |            |                           |

**4 1/2" POTS... 79¢**

**2 QT. CONTAINERS... 37¢**

**GALLON CAN RHUBARB \$1.98**

**SEED POTATOES & ONION SETS**

**SAXTONS GARDEN center inc.**

587 W. ANN ARBOR TRAIL PLYMOUTH • 453-6250

"EVERYTHING FOR THE GARDEN BUT THE RAIN"  
HOURS: Daily 9-6 Mon & Fri 9-8 Sat. 9-5 Sun. 10-2

## Colonial Pizza



**Delivers Hot Pizza!!!**

with our radio equipped trucks

**198 W. LIBERTY** Located in **PLYMOUTH, MICH.** Old Village  
PHONE **459-5900**

**Free Delivery within 30 Minutes**

# Chief sluggers face crucial game with Mott

**BY DONNA LOMAS**  
The Canton girls softball team narrowly missed a Western Six League win Monday afternoon at the Walled Lake Western field, 9-8.

The Chiefs are now 2-2 in the Western Six League and sport a 3-2 record overall.

The Chiefs led up to the seventh inning, 8-7, until the

Walled Lake Squad had two more hits and wrapped the inning up one ahead of the Chiefs.

The Chiefs had only three hits during the entire game, coming from Judy Freeman in the third and seventh inning and a hit from Kim Zoladz. Eleven walks went to bases from the "fast" Walled Lake pitcher, said softball coach Joan Ryan.

"It was the home field advantage that finally got to us," she said. "We were ahead slightly but then they got those runs in the last innings."

Kim Young led off in the seventh inning and got to first base safe on an error. Jean Krasnovitz walked, Zoladz stole third. The Chiefs had another walk and bases were loaded. Krasnovitz went out while stealing third, and then Freeman's double scored two runs.

Sue Rekuc walked and then scored on a wild pitch, after Freeman went to third base on a pass ball.

A crucial game will be today (Wednesday) against Waterford Mott, also a Western Six foe. The Chiefs now have a chance to break the tie (2-2) and put

themselves ahead in the league race.

"I think we are the stronger - slightly - of the two teams," said Ryan. "Our problem has been one of morale, confidence. Our injured shortstop is recovered now, and we think that

with her in, it will give the team a boost in spirit.

"Mott is not strong on pitching, and Lucy (Howe) does a good job for us," Ryan said.

"We should be able to control our errors and play well today."

## Chief netters blast W. Lake

**BY CHAS CHILD**  
Number one singles Steve Paisley came from behind to whip his Walled Lake opponent, 4-6, 6-2, 6-3, leading the Chiefs to a 6-1 win over Walled Lake Western Monday on their home courts.

Kurt Hofner, number two singles, had an "easy time" according to coach Jim Hayes, walking all over his opponent, 6-0, 6-0.

Third singles, Keene, played "very well in a losing effort," Hayes said. He took the first set, 7-5, but dropped the next two, 6-1, 6-4. "For only a sophomore, he's playing very well," Hayes said. "He's going

to be a real good player in the future."

Chris Davio, at the fourth singles spot, won 0-6, 6-4, 6-1. Hayes said he's only lost one mat all season. "He's been real steady all season."

Canton swept all the doubles matches. The number one team of Time Wise and Don Perchard took their opponents, 4-6, 6-2, 6-1; Paul Ardanowski and Doug Hetu at second doubles won 6-3, 6-1 and Matt Norris and Stuart Sobczynski won 6-3, 6-0.

Hayes had special praise for the third doubles team of Norris and Sobczynski. "They're improving a lot, and are playing as well as anybody on the team."



### Special Events

#### Restaurant & Video Disco

**MONDAY FASHION DISCO PARTY**

Gazebo Room Disco  
7 P.M. Cover Charge \$4.50

**TUESDAY 60'S PARTY "MOTOWN SOUNDS"**

Gazebo Room Disco  
Starting 8 P.M.

**WEDNESDAY SUMMERTIME DRINKS**

Half-price  
9 P.M. - 11 P.M.

**THURSDAY LADIES NIGHT**

Half-price  
Gazebo Room Disco

**FRIDAY GAZEBO ROOM DISCO**

No cover charge before 8 P.M.

**SATURDAY GAZEBO ROOM DISCO**

No cover charge before 8 P.M.

**SUNDAY WINE TASTING**

Gazebo Room  
8 P.M. - 9:30 P.M.

DOUBLES SERVED 3 P.M. - 2 A.M.

MONDAY & TUESDAY

DOUBLES SERVED 3 P.M. - 8 P.M.

WEDNESDAY - SATURDAY



(MAIN ST. ENTRANCE)

1/2 BLK. SOUTH OF ANN ARBOR TRAIL

PLYMOUTH, MICHIGAN

459-6370

555 Forest

## Rock golfers set record

**BY DONNA LOMAS**

The Salem girls golf team set a new record at Glen Oaks golf course last Thursday in their match with Willow Run, 209-219.

"It was a superb score," said Salem golf coach Bob Waters, "probably the best one we will turn in this year."

The Rocks shot a pair of 51's last Thursday, with Nancy Grotz and Joanne Silagzyi hitting the low. Frosh Meg Magee shot a 53 for the day and Betty Delano shot a 54.

Last Monday the golfers had a match with Brighton, rescheduled because of rain at the previous date.

Best score for the Rocks went to Anne Arthur with a 53, followed by Grotz with a 57 and Magee with a 59. The overall highlight of that match was a score of 40 for Brighton golfer Beth Williams.

## MICHIGAN'S VACATION CENTER

Plan your summer vacation now with a luxury Motor Lodge from Michigan's Travel Headquarters.



**Travco 290 TRAVSTAR**

SEE THE ALL-NEW MOTORHOME—CRAFTSMANSHIP AT ITS FINEST!

Gorgeous, new color-coordinated furniture fabrics, lush deep pile carpeting. Exciting new pastel body colors — harmonizing deeper-tone accent striping. Beautiful new walnut paneling and cabinets. Concealed hardware. A wide range of new floor plans — one's just right for your family. New handling ease and riding comfort. Travco high-integrity steel-and-fiberglass construction provides strength and reliability. 32', 29' and 27' models.



*The Executive*

Designer interiors. Color TV. Microwave oven. AM/FM stereo and tape deck. Bar Blender. Air-Conditioning. Self-Contained pushbutton environment. Collateral Construction, a sandwich of steel, aluminum, Styrofoam, fiberglass and plywood. New, all fiberglass exterior. Models 26 to the exquisite Model 35.

• HUGE INVENTORY • FACTORY AUTHORIZED SERVICE • TRADE-INS •



*The Diplomat 1*

Graceful, smooth flowing aerodynamic styling. Beautiful new color-coordinated interior. Numerous floor plans to choose from. Roomy overhead astro compartment — double bed or twins. New walnut paneling and cabinets — concealed hardware, rear bath with separate tub-shower compartment. Rugged Travco steel-and-fiberglass construction.



**TRAVCO L'Esprit™**

SEE THE NEW UNIQUE ADVANCE DESIGN MINI MOTORHOME!

Graceful, smooth flowing aerodynamic styling. Beautiful new color-coordinated interior. Numerous floor plans to choose from. Roomy overhead astro compartment — double bed or twins. New walnut paneling and cabinets — concealed hardware, rear bath with separate tub-shower compartment. Rugged Travco steel-and-fiberglass construction.

WE HAVE A COMPLETE SELECTION OF ALL MODELS IN STOCK TO CHOOSE FROM. 10 YR. FINANCING. WE TAKE TRADES.

"A Complete Parts & Service Motorhome Facility"

### LLOYD BRIDGES

## TRAVELAND

Chelsea—12 Mi. W. of Ann Arbor-475-1347 OR TOLL FREE 1-800-482-9177  
SALES HOURS: Mon. thru Thurs. 9 A.M. to 8:30 P.M. Fri. & Sat. 9 A.M. to 6 P.M.



# Rock thinclads tie for sixth in RU Relays

BY DONNA LOMAS

The Salem boys track team tied for sixth place out of 16 schools in the Redford Relays held last Saturday at Redford Churchill came from behind in the last running events to take the win for the fourth year in a row.

"Our goal was to score in four out of the five field events," said Gary Balconi, Salem track coach. "We scored in three out of five, so we nearly made it. We did have personal bests and broke some school records too."

School records were broken in the high jump, the discus and pole vaulting events. The trio of Scott Kapler, Mark Coma and Dennis Ogden made new records with their combined jumps of 36'9"; Kapler took second place in individual going 13'3" for a personal best also, Coma jumped 11'6" and Ogden went 12'.

In the discus relay, Bob Dasher, Jerry Ottenhoff and Chris Ritchey took third place. Respective distances went to Dasher with 146'2", Ottenhoff with 111'3" and Ritchey went 118'4". In the high jump

Saturday, Mike Skone, Mike Christie and Henschew came in fifth, setting a new school record of 17'4" as a team in the high jump.

The Rocks won the two-mile relay - something Balconi said they set out to do.

"We were out to win the two mile relay and we did a superb job," he said.

The quartet of Tom Covington, Tom Rubadue, Chris Ritchey and Walt White each ran a half mile.

Personal bests went to Bob Stiffler in the four mile relay with a time of 4:54.6 for one mile; Kevin Warrara in the distance medley, 2:12; Tom Carl in the sprint medley turned in his best time of :23.5. In the shuttle hurdles, Mike Christie leapt 14'8" for his personal best. The 13'3" height by Kapler in the vault was a best, as was the 1:59.5 timing by White.

In the Edsel Ford meet Thursday, Edsel Ford "was as tough as we expected," said Balconi.

The Rocks won the long jump with Henschew, who went 20' Dasher won the discus with a distance of 131'5", and also the shotput with 46'1". White won the two mile with a time of 9:48.3.

The Rocks face Allen Park this

Thursday at the CEP track. "We believe we can win this one," said Balconi. "We want to run good times, not only to win, but also because our regional entries will be turned in Friday. So we'll be working hard for that."

## Chiefs nip Rice in twin bill

BY CRAIG BRASS

The Canton baseball squad nipped Brother Rice in a 5-0, 5-4 doubleheader last Saturday afternoon, when a lead-off home run by Jeff Campbell at the bottom of the eleventh inning clinched the second win for the Chiefs.

The Chiefs were within one inning of putting the game on ice, but couldn't shut down the Braves. A single and two Canton errors gave Rice their third run in the top of the seventh sending

the contest into extra innings late Saturday afternoon.

The Chiefs collected two more runs, one in the second and one in the sixth as easily defeating Rice in the first game.

Steve Morman led all hitters Saturday as he collected five hits in seven trips including two triples. He also drove in four runs and scored one himself.

Senior Rob Mandle scattered five singles in eight trips while scoring three times. Collins added three hits while reaching base five times and scoring four runs.

The Chief batsmen collected twenty-one hits and ten runs in the two games while Stingy defense gave up eleven hits, (all singles) and only two earned runs.

"We played a class group of kids today," Coach Fred Crissey said later. "They gave us their best shot but our kids wanted it more. We just wouldn't give up."

out against Saline," said coach, John Crosson, as the team had an inflated score of 281 to 225 for Saline. Canton came back to beat Willow Run two days later, however, 237-251.

Coach Crosson was hopeful before yesterday's match with Salem. Although Salem is 3-1, their one loss came against Brighton. The Rocks won the first meeting of the two teams by 10 strokes.

The Chiefs travel to Saline for a league match tomorrow, and will compete in the Willow Run Invitational Friday, beginning at 9:30 a.m.

## Chief golfers 2-2 in league

BY MATT NORRIS

Canton High golfers evened their Central Five record to 2-2 at the halfway point of the season last Tuesday, beating Brighton, 226-241.

Canton's Peggy Visser turned in a 53, while Cathy Andersen and Sharlene Rodden tallied 54 and 57. Kelly Heaton scored fourth for the Chiefs with a 62. All four Canton golfers were behind Brighton medalist Beth Thompson, who scored 46 on the Brighton course.

The Chiefs also split two matches Tuesday and Thursday, April 26 and 28. "We bombed

## This Friday in Canton gym Superstar? Alright, you are!

BY MATT NORRIS

The Canton High boys and girls basketball teams are sponsoring a SuperStar Night this Friday, May 13, in the Canton gym.

All citizens in the community are eligible to participate in the individual and team events, with prizes being given to the winners of each of the 15 categories.

All money raised will go towards the Chief's boy's and girl's basketball teams at Canton.

Teams of four people (two males and two females) are eligible to compete in the three sessions. Session A begins at 7:00 and includes bicycle. Session B, beginning at 8:00, includes three-legged swimming races and badminton matches. The third session at 9:00 will include team volleyball, basketball, and tug-of-war competition.

Tickets are available at the Canton gym Friday night, and are 25 cents for admission and 25 cents for each event. Prizes will be donated by local merchants.

MIDDLE SCHOOL BOYS BASEBALL AND GIRLS SOFTBALL GAMES 4:00 - 6:15 P.M.

May 10 - Pioneer at Central  
May 12 - East at Pioneer  
May 17 - Central at Pioneer  
May 19 - Pioneer at West

May 23 - Pioneer at East  
May 25 - West at Pioneer  
May 31 - Pioneer at Central

## Hurler Ford sets record

BY MATT NORRIS

Canton High girls track team lost a close meet to Waterford Mott Thursday, 73-63. The loss, second in the league for the Chiefs, was run at Waterford. The squad has a 3-3 overall record.

Although Canton runners broke three school records and won seven first places, the meet was decided in the next-to-last event, the 220 yard race. Veronica Gray ran a good time of :27.5, but was defeated by a state-ranked Mott girl in the race.

Senior Meaghan Ford broke two school records Thursday, hurling the discus 84'1", and dashing to an :11.8 second place in the 100. The mile relay team of Beth Richardson, Cheryle Coble, Jennifer Tregembo and Lynne Bigelow swept their race in 4:26.9, also a new Canton mark.

Other firsts included Gray in the high jump at 4'8" Kathy Kidston's 2:47.3 time in the half mile and Bigelow in the low hurdles. Tregembo also showed improvement in the 440 yard run with a 1:06.2 first place. The 880 relay team of Tregembo, Richardson, Bigelow, and Gray posted a 1:51.9 first place time. The team has one of the best times in the area, according to coach Barb Winn.

The Chiefs have a good chance at winning the remaining three Western Six dual meets, added Winn. "We should beat Northville and Harrison, but it will close with Churchill," said the coach. The team competes

### DISCOUNT AUTO PARTS

**SAVE up to \$2.00**

Take an **EXTRA 10% OFF** our regular low prices on **SIMONIZ** products and other automotive purchases



Our Price **\$4.79**



Our Price **\$2.85**



Our Price **\$3.30**

Buy SIMONIZ Pre-Soft, Liquid, ROYALE, or any other SIMONIZ product and we'll mail you a 10% refund (limit \$2.00) on your total Automotive purchases. Enclose proof of purchase listed below from both Simoniz and other automotive products.

- SIMONIZ Pre-Soft - cut out logo from plastic overcap.
- SIMONIZ Liquid - label from bottle front.
- SIMONIZ ROYALE - Pro-Stroke applicator instructions disc.
- SIMONIZ logo tracing from other SIMONIZ products
- PLUS a cash register receipt for up to \$20.00 worth of Automotive products purchases

MAIL TO: SIMONIZ REFUND  
P.O. Box 7077 • Chicago, Ill. 60677

NAME \_\_\_\_\_

ADDRESS \_\_\_\_\_

CITY \_\_\_\_\_ STATE \_\_\_\_\_ ZIP \_\_\_\_\_

One refund per family. Void where prohibited, licensed, restricted or taxed. Refund request must be made on this official order form. Please allow 4 to 6 weeks for refund. Offer Expires October 1, 1977.

CO5577

**SPARK PLUGS 84¢**

For most cars Resistors  
Champion only **95¢**

**SILOCONE WIRES \$14.95**

<b>Oil Filters</b>	<b>Air Cleaners</b>
<b>99¢</b>	<b>\$1.94</b> all cars
<b>Burglar Alarms</b>	<b>Diesel Horns</b>
<b>\$14.95</b>	<b>\$15.95</b>



**347 N. Main St.**  
(Between Starkweather & Amelia)  
**455-4050**

# Salem sluggers split two Sub 8 league contests



## BUSY BEE CRAFTS

**1082 S. Main 455-8560**

Register Now

**NEEDLEPOINTE**  
Mon. May 23, 7-9 p.m.  
Learn 44 stitches \$20 for 5 weeks

**\* MACRAME & BASKET WEAVING**  
Wed. May 25 10-12 noon  
7-9 P.M. Mrs. Kabel

Thurs. May 26 7-9 P.M.  
\$12.50 for 5 weeks

Learn to make this darling doll at  
**DIP N' DRAPE**  
May 16 7-9 P.M.  
\$7.50 2 weeks Supplies included

Closed Memorial Weekend Sat. May 28 - 30.



BY MATT NORRIS  
Salem softball team split two Suburban Eight contests last week, beating Bentley 8-4 Friday, and losing to Dearborn 6-3 on Tuesday. The Rocks are tied with Edsel Ford and Dearborn for first place in the league, each owning a 5-2 record.

Sophomore pitcher Jan Boyd picked up the win at Bentley Friday, allowing only four hits in four innings. Debbie Pitera pitched the last three stanzas, and struck out eight batters while giving up no hits.

The Rock's offensive attack was led by Cindy Cindrich, who had two of Salem's eight hits, and Doris Hoelscher, who had one hit and scored three runs.

Salem led Dearborn for five innings Tuesday, but the Pioneers jumped ahead on a two-out rally in the sixth inning, winning 6-3.

With a 3-2 lead in the bottom of the sixth, Salem pitcher Pitera allowed a single and two walks to load the bases. Pitera walked in the tying run, and a fielder's choice play allowed two more runs to score. Pitera walked one more batter before the inning ended. The Rocks couldn't produce any runs in their half of the seventh inning.

Salem scored their three runs on five hits in the first and fifth innings. Cindrich singled and was hit in by Kathy Lehmann in the first stanza. Pitera doubled in the fifth inning and scored on a basehit by Cindrich. Lehmann collected her second RBI of the day, scoring Cindrich on a single.

The Rocks face non-league Thurston at Thurston tomorrow, and travel to Belleville Friday for a Suburban Eight contest.

## Salem thinclads improve

The ever-improving Salem girls track squad upped its score from last week's meet, but a tougher Suburban Eight Edsel Ford scored a win at last Wednesday's meet, 78-58.

The Rocks took firsts in the 880 relay, the 440 relay, the long jump and the low hurdles.

In the 880, Kathy Sample took first with a time of 2:34. Cindy Levielle was second with 2:36 and frosh Kim Brown came in fourth with a clocking of 2:41.

Joanne Langekabel took first in the low hurdles with

:16.2, Erin Lucas was third with :17.8. The 440 relay team of Ann Maixner, Polly Richards, Sandy Ezzo and Joanne Langkabel was first with :54.7. Langkabel also took a second in the 220 relay and a third in the long jump.

Sprinters Richard and Maixner took second and third in the 100 yard respectively, Trisha Mullen took a fourth place with 12.09. In the mile, Sarah Marks took a third place with a time of 6:12, down from 6:24.

Julie Prchlik took second place in the shotput and discus. Prchlik's best throw was in the shotput was at the meet, 29'2 1/2". Frosh Linda Majors took third place with 24'1 1/2" on her first try. Prchlik threw the discus a distance of 83'4"

## Finley signs

Salem senior and All-American swimmer Ron Finley has chosen Western Kentucky University, signing a letter of intent for a full four-year scholarship.

Finley won the state title in the 100 yard backstroke and finished fourth in the state in the 200 yard freestyle this past swim season.

## Bortens finishes

## Bicentennial jog

John Bortens, 50, of 41530 Greenbriar Lane completed last Thursday night 1,776 miles in the National Jogging Assoc. Bicentennial Jog.

Bortens, who started the jogging on April 5 of last year, has been jogging for several years. His son, Robert, has completed 1,850 jogging miles.

Bortens completed the jog at Central Middle School track.

## District playoffs set

The results of the District draw for eventual State Tournament playoffs in CEP varsity sports are as follows:

Canton baseball will meet Romulus at Romulus on May 17. Salem drew Ann Arbor Huron, and will play at Huron on Wednesday, May 18.

Canton softball drew a bye first round, will play Adrian at Adrian. Salem softball also drew a bye, it will play the winner of the Brighton and Ann Arbor Huron game. No dates for the softball games have been set yet.

## Tripp triples twice

Terri Tripp hit two triples and single last Thursday to lead the Salem junior varsity softball team past Clarenceville, 11-6.

Pitcher Lisa Cannon struck out six, raising the Salem record to 3-2.

## Soccer stats

PLYMOUTH SOCCER SCORES  
BOY'S 10 AND UNDER - DIV. 1  
Farmington I: 7 - Plymouth I: 1;  
Plymouth II: 6 - N.Ville II: 3.

BOY'S 10 AND UNDER - DIV. 2  
Plymouth III: 4 - Farmington II: 1;  
Livonia V: 2 - Plymouth V: 0;  
N.Ville III: 7 - Plymouth IV: 1.

BOY'S 10 AND UNDER - DIV. 3  
Livonia VIII: 11 - Plymouth VIII: 0;  
Plymouth VII: 4 - N.Ville IV: 0.  
BOY'S 10 AND UNDER - DIV. 4  
Plymouth IX: 8 - N.Ville VIII: 1;  
Plymouth X: 6 - N.Ville VII: 0.

BOY'S 12 AND UNDER - DIV. 1  
Farmington I: 3 - Plymouth II: 1;  
Livonia I: 6 - Plymouth I: 0.

BOY'S 12 AND UNDER - DIV. 2  
Livonia V: 4 - Plymouth III: 2; Plymouth IV: 1 - Farmington III: 1; Farmington III: 7 - Plymouth III: 2; Plymouth IV: 2 - N.Ville III: 0.

BOY'S 12 AND UNDER - DIV. 3  
Plymouth V: 1 - Livonia XI: 1; Livonia XI: 1; Livonia X: 7 - Plymouth VI: 1; Plymouth V: 5 - Plymouth VI: 1.

BOY'S 14 AND UNDER - DIV. A  
Plymouth: 4 - Livonia II: 0.  
BOY'S 14 AND UNDER - DIV. B  
Plymouth I: 1 - Livonia I: 1.

BOY'S 19 AND UNDER  
Farmington: 3 - Plymouth II: 1.  
GIRL'S 10 AND UNDER  
Plymouth II: 2 - N.Ville I: 0; Plymouth I: 6 - Farmington: 0.

GIRL'S 12 AND UNDER  
Farmington: 3 - Plymouth I: 1; N.Ville I: 2 - Plymouth II: 1.

GIRL'S 14 AND UNDER  
Plymouth: 9 - Livonia I: 2.  
GIRL'S 19 AND UNDER

## Williams Brick Panel Siding is

### 50% Better Than Aluminum Siding

**24**  
kinds & colors to choose

**Here's Why . . .**

- Over **twice** the insulation value, including covering the foundation
- Zero maintenance

- Over 50% more increased home valuation than aluminum siding.
- Absolutely will not dent, fade, or chalk. "It's Brick!"

Williams Panel Brick is genuine 1/2" thick kiln-fired brick, bonded to a 1/2" thick insulation panel.

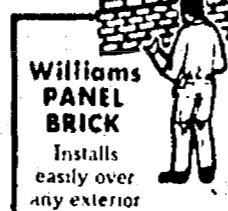

**Williams PANEL BRICK**  
Installs easily over any exterior

**FREE** At no extra charge — 42"x36" front or side door awning installed with your complete Williams panel brick home.

Offer expires May 30th, 1977.

Released and recommended by FHA & BOCA as brick veneer siding

Our prices will never be lower!

## Williams PANEL BRICK

25257 W. 8 Mile 538-6635



# Real Estate

BY WILLIAM DECKER

REALTOR

### VACATION HOUSE AND TAX DEFERMENT

Among the benefits of being a homeowner are the unique tax advantages available. One of them to be wary of is the provision which allows you to defer paying income tax on any profit made from the sale of your home if you buy a more expensive one within a certain amount of time. It does not apply in all cases.

For example, if you sell a vacation home at a \$2,000 profit and promptly buy a much more expensive place, can you defer paying the income tax on the profit? The answer is no!

This tax break is available only when both the house sold and the house purchased serve as your principle residence. A vacation house doesn't qualify. However, if you owned the dwelling for more than the required time to allow the profit to be taxed as long term capital gains (6 months in 1966, 9 months in 1977 and one year after that), the \$2,000 profit would only be taxed at half the normal rate.

★

If there is anything we can do to help you in the field of real estate, please phone or drop in at REALTY WORLD, Wm. Decker, Inc. Realtors, 670 S. Main St. Plymouth. Phone: 455 - 8400. We're here to help!

## Cager DeBear to play in S'Craft Classic

Senior captain and forward on the Salem basketball team last season, Chris deBear has been chosen to play in the Schoolcraft Classic.

Earvin "Magic" Johnson, All American from Lansing, will head up the team deBear is on. DeBear will be part of the team, which includes Bentley's

Flo Humm and Northville's Tony Armada, all honored last season for their efforts.

The game will be played at 7 p.m. Saturday, May 14 at the Schoolcraft gym, 18600 Haggerty in Livonia. Tickets are \$2 for adults, and \$1 for students. Proceeds benefit the Schoolcraft Athletic Dept.

## Sports happenings

Day	Event	Location	Time
Weds. May 11	C. baseball	W. Mott	T 4 p.m.
	C. girls track	N.Ville	H 3:30
	C. boys track	N.Ville	T 3:30
	C. tennis	W. Mott	T 4 p.m.
	C. softball	W. Mott	H 4 p.m.
Thurs. May 12	S. girls track	A. Park	T 4 p.m.
	S. boys track	A. Park	H 3:30
	S. softball	Thurston	T 4 p.m.
	S. girls golf	Brighton	H 4 p.m.
	C. girls golf	Saline	T 4 p.m.
Fri. May 13	Superstar Night	Canton gym	7 p.m.
	S. baseball	B.Ville	H 4 p.m.



# 'Slow growth in Canton' -- report

Cont. from Pg. 2  
Recom. No. 4

This group believes Canton Township officials should have a system of phased growth developed for Canton Township. (12-2)

By phased growth we imply specifying areas that are already for development now and connected to existing development, those that are at various states of readiness, and those that have not yet attained any factors relating to readiness for development and thereby designating areas that would be allowed to develop first, second, and so on, similar to what was done in Ramapo, New York. This technique could be developed in part through impact zoning.

Recom. No. 5 Canton Township should curtail the extension of public utilities and facilities such as sewers into certain areas. (11-3)

In that there is limited sewer capacity, extension of sewer lines to much of western Canton, is not warranted, in the minds of most committee members. Such extensions would represent excessive costs for the small amount of service that could be provided. Further, curtailing such extensions would be consistent with regional guidelines.

Recom. No. 6 Canton Township officials should consider the public purchase of natural development rights in present agricultural zones. (10-yes, 2-if cheaper, 2-no)

This recommendation is not to be confused with transfer of development rights, which we feel would be too complicated a system to perfect for Canton. By public purchase of development rights, we refer to purchase by the township. We realize the tax implications of such a recommendation; however, we believe the retention of agricultural land in Michigan is vital to its future welfare. Further, we believe that it could be far cheaper in the long run in terms of costs, than total development.

Recom. No. 7 Canton Township officials should consider developing and adopting a yearly quota system on residential construction to control the rate of growth until we reach our sewer capacity. (9-5)

Such a quota system would insure orderly growth in those already platted, ready subdivisions, such that we could continue to grow some each year, prior to the advent of the Huron Valley Interceptor System, rather than to reach our sewer capacity in a very short time and be left with a situation where no sewered growth could be accommodated for several years.

Recom. No. 8 Canton Township officials should consider the outright purchase of some open space land. (7-7)

Some members specified, this option as usable for creating a buffer zone between farms and developed areas to reduce the incidence of nuisance complaints. Many of the no votes on this item said they were in favor of purchase of land by the township for recreational purposes, but not beyond this.

This group does not feel that any one growth control technique alone could reduce the diverse facets of growth in Canton to a manageable concept. Hence, we feel a management system for Canton would need to include most if not all of these recommendations.

It was further the consensus of this group (10-4) that we would hope to see only in-filling on the east and northwest sectors of the Township, reserving space for recreation, and never developing the agricultural lands. If retention of agricultural lands becomes impossible, then seven members of the ten supporting retention of agricultural lands, would like to see the agricultural lands restricted to large lot (1 to 10 acre) subdivisions.

We feel there are numerous justifications for retention of agricultural lands. First, land is needed to feed the populace of this state. We already have a shortage of agricultural lands in Michigan, and annually the remaining agricultural lands diminish. All lands presently in agricultural production need to remain in such production. Further, we feel there is justification for such action in the limited sewer capacity. Further, the SEMCOG Background Papers state that there will exist in the proposed sewer system for 1990 (which excludes the western agricultural lands of Canton) room for 835,000 sewer hook-ups in the region, while only 400,000 new households are expected in the region. It should be mentioned that the costs of sprawl are exponential in terms of energy consumption.

# Crier Classifieds

DEADLINE 5 p.m. MONDAY

## HELP WANTED

Are you available for temporary assignment? If you have office skills, register now for short or long term assignments.

TEMPORARY NO FEE

College students and teachers register now for summer work.

SECRETARIES  
TYPISTS  
DICTOPHONE  
SWITCH BOARD  
KEYPUNCH  
GENERAL OFFICE SKILLS

Work where you want and when you want. For your convenience we have seven interviewing offices.

LIVONIA 525-0330

10 A.M. to 3 P.M.  
Mon. Thurs. Fri.  
or  
967-0339

WITT SERVICES

Responsible experienced maintenance person or couple to live in senior citizen apartment building. Salary includes rent free apartment. Call 455-3670 between 1 p.m. and 3 p.m.

## AVON

Spring into a career this spring! Bring beauty, gifts and other great Avon products to your area. High \$. Flexible hours. Call 291-7862

Immediate openings for Cook. Apply in person at West Trail Nursing Home 395 West Ann Arbor Trail.

Run out of money before you run out of month? Turn the tables with extra income. The AMWAY way. Get the whole story - phone 455-9132.

Immediate Openings for RN and LPN Apply in person West Trail Nursing Home 395 West Ann Arbor Trail.

Need money? Distributors wanted part time, full time. Shaklee Products. 459-1879.

Wanted, experienced beauty operator with clientele. Apply at Nu-Yu Hair Salon, 176 S. Harvey. 459-6050

## HELP WANTED

Earn extra money the Amway way. As little as \$15 gets you started in a business of your own. Get the whole story. Phone 459-9120.

Wanted: Tool maker, bridge port operator, lathe operator, machine builder, mill hands, bench hands, apply at Witomatic, Inc. 22605 Heslip Dr., Novi, Michigan.

PLEASANT WAY TO EARN  
As an Amway distributor of nationally known products in your community if you wish. We will train you. 459-9860.

Part-time help wanted, evenings and weekends. Applications taken daily, except Tues. and Sunday. K-Mart 5725 Sheldon. (At Ford Road.)

## HELP WANTED

Retail clerks, cashier and stock girl. Full time and part time for a new Levi's family store to open Aug 3 Twelve Oaks Mall in Novi. All benefits. Send confidential resume, to Box 47, 572 S. Harvey, Plymouth.

Experienced legal secretary for an established Plymouth office. 453-7081.

## VEHICLES FOR SALE

'73 DODGE VAN T200 V-8 PS, PB, Custom int. FM stereo New chrome & paint. Looks sharp \$3500 or best offer. 453-7582 between 3 and 10 p.m.

1976 CORVETTE, flame orange loaded, 5,000 miles. Call Mon-fri 8 a.m. to 5 p.m. 453-1118. After 5 p.m. and weekends 459-5798.

1973 YAMAHA 250 Enduro 3,000 miles, adult owned \$475 453-3217.

HOLIDAY RAMBLER TRAVEL TRAILER: '66. 23' overall, electric jack, awning, swaybars, mirrors and other equipment. Good condition. Call 453-3562.

1968 Fairlane, 2 door hard top Automatic, economical and dependable. Good brakes, tires, etc. \$285. 455-2124.

## SITUATIONS WANTED

Handy man, general repair. Free estimates, experienced, with references. 455-4541.

## CLASSES

Plan 6 teacher, now accepting beginning and advanced students in her home. Call 981-1371.

## HOUSE FOR RENT

Canton - 3 bedroom, colonial, 1 1/2 baths, family room, fireplace, all appliances, garage. 6' privacy fence. Sue, 722-2069 week days.

## APT FOR RENT

City of Plymouth Duplex. 2 bedroom, stove, refrig, disp, air, carpet, no pets \$300 plus security. 1 yr. lease. 455-0391

## LANDSCAPING

Birch Trees and clumps early planting best results. 11211 Haggerty Rd.

## SERVICES

NEWCOMERS to Plymouth area Local merchants welcome you with lots of free gifts including a map from Plymouth Community Federal Credit Union. Call Plymouth Newcomer's Service. 455-9132.

Guitar lessons for serious beginners. \$2.50 per half hour in my home. Call Rich 453-1768

## RUMMAGE SALES

St. John's Episcopal Church 574 Sheldon, Friday May 13. 9 a.m. to 5:30 p.m. French room, beanbag chair and antique night stand specials.

## GARAGE SALES

Neighborhood Garage Sale. May 12, 13, 14. Holiday Park Sub off Joy. 39689 Cather Drive.

## Porch Sale

Miniature items for sale plus many other misc. items Friday 10 - 5 p.m.; Saturday 12-6 p.m. 638 S. Harvey, Ply.

## Yard Sale

May 14, 10-4, 1433 Palmer, Plymouth (W. off Main at Clark gas) Tricycle, child's bike, skis, games, towels, jewelry, toys, books.

## PLYMOUTH-CANTON COMMUNITY SCHOOLS BOARD OF EDUCATION MINUTES

This is a synopsis of minutes of a regular meeting of the Plymouth-Canton Board of Education, held on April 25, 1977. Member McClendon was absent from the meeting. Unless otherwise noted, all motions were passed unanimously by the six members in attendance.

Citizens Suggestions: Mr. Thomas Ronayne and Mr. Stan Bacher both requested more information about the 45-15 proposed program, especially regarding the Blockstart system and on the Track "A" Schedule. Mrs. Sylvia Stetz asked the Board to support the Helping Hand program as proposed by the School Council and by the Plymouth Jaycee Auxiliary.

Administration Reports: Supt. Hoben reported on legal counsel's opinion regarding placement of advisory vote on the June 13 school election ballot. In reply to Member Yack's suggestion, Mr. Hoben noted that such vote would be illegal in itself as well as possible illegal use of tax monies.

New Business: Bills for payment were approved as presented, (with the exception of check No. 28862) in the total amount of \$1,079,502.70. A leave of absence was granted to Norma E. Kenzie, Salem High School. The Board then voted to accept the summary of results of the April 23, 1977 election for the bond issue and the millage renewal, as presented by the School Board of Canvassers. The Board was most grateful to the large number of citizens who voted. An alternative procedure for

the school census/survey was approved which would provide for circulation to several sources throughout the community and not be done on a door-to-door basis. The Helping-Hand proposal for the Plymouth-Canton Community Schools as organized by the School Council and by the Jaycee Auxiliary was accepted by the Board, and administration asked to cooperate in the program in every way possible. A workshop on May 2 was approved so that a proposal for placing a different bond issue on the June 13 ballot could be discussed.

Policies: A new policy was approved on Public Access to Records, providing for compliance with the new Freedom of Information Act passed by the State Legislature.

Concerns: Board members asked for more information from administration on possible inclusion of fast-food service for school lunch programs for a workshop to discuss the 45-15 program schedules; for preparation of policies on bidding procedure for purchases, and on employee alcoholism, as well as procedure for setting up specific dates for workshops. A seminar in Lansing on May 20-21 on administrative appraisal was announced. The meeting was then adjourned at 8:25 to a workshop session to discuss preliminary plans for possible bond issue on the June 13 ballot.

THIS IS A SYNOPSIS OF THE MINUTES OF THIS MEETING, AND COMPLETE INFORMATION OR TAPE RECORDING OF THE MEETING CAN BE OBTAINED AT THE BOARD OF EDUCATION OFFICES, 454 S. HARVEY STREET.

See the world from your station wagon!

**WANTED**  
**CRIER Route Driver**  
Call: **453-6900**

\$2<sup>50</sup> for 10 Words  
10¢ for each  
additional Word

# Crier Classifieds

CALL  
453-6900

DEADLINE: MONDAY

**POSTING AND FILING OF CITY COMMISSION MINUTES  
CITY OF PLYMOUTH, MICHIGAN**

Notice is hereby given that on the 6th day of May, 1977, true copies of the minutes of the regular meeting of the City Commission held on Monday, April 25, 1977, at 7:30 p.m., were posted on the official bulletin boards of the City of Plymouth, located at the Southeasterly corner of the intersection of S. Main Street and Penniman Avenue; the Southeasterly corner of the intersection of Starkweather Avenue and W. Liberty Street; and the South entrance of the Central Parking Lot facing S. Harvey Street, and also on the bulletin board in the City Hall at 201 S. Main Street. These minutes are posted in accordance with Section 5.11 of the City Charter for the benefit and information of all interested citizens of the City of Plymouth.



Paul V. Brumfield  
City Clerk

**GARAGE SALES**

3 family, furniture, appliances, clothing. 44140 Arlington, May 12, 13, 14 9 a.m. to 6 p.m. Sheldon and Joy Rd.

Lucky 13 Garage Sale - Friday May 13. Over 20 contributors, something for everyone. 7334 Irongate in Canton, north off Warren, one block east of Sheldon. 9 a.m. to 7 p.m.

**ARTICLES FOR SALE**

Squash Blossom Necklace. Best offer. 994-8002.

Girls 3 speed bicycle. Brand new 19 inch. \$60. Call 459-1179 after 5 p.m.

4 pieces ludwig drum and symbol set - metallic red \$100; 20 inch electric, white, 3 burner apt. size stove \$35; 3 speed black hawthorn girls bike \$20. 453-7167.

**POSTING AND FILING OF CITY COMMISSION MINUTES  
CITY OF PLYMOUTH, MICHIGAN**

Notice is hereby given that on the 6th day of May, 1977, true copies of the minutes of the regular meeting of the City Commission held on Monday, April 18, 1977, at 7:30 p.m., were posted on the official bulletin boards of the City of Plymouth, located at the Southeasterly corner of the intersection of S. Main Street and Penniman Avenue; the Southeasterly corner of the intersection of Starkweather Avenue and W. Liberty Street; the South entrance of the Central Parking Lot facing S. Harvey Street, and also on the bulletin board in the City Hall at 201 S. Main Street. These minutes are posted in accordance with Section 5.11 of the City Charter for the benefit and information of all interested citizens of the City of Plymouth.



Paul V. Brumfield  
City Clerk



**C.E.T.A. POSITIONS OPEN**

The CITY OF PLYMOUTH has openings for the following C.E.T.A. positions:

CLERK TYPIST  
RECREATION MAINTENANCE MAN

Applicants must be a resident of the City of Plymouth and must meet C.E.T.A. eligibility requirements which call for hiring low income and long-term unemployed persons. Unemployed veterans are especially encouraged to apply. Applicants must contact the Michigan Employment Security Commission, 8825 General Drive, Plymouth, Michigan 48170.

**CITY OF PLYMOUTH, MICHIGAN**

The City of Plymouth, Michigan, has for sale and development approximately 1.39 acres of land in the PLYMOUTH INDUSTRIAL PARK described as:

That part of the S.W. 1/4 of Section 25, T. 1 S., R. 8 E., described as beginning at a point distant S. 80 degrees 21' E. along the E. and W. 1/4 Section line, 80 ft., and S. 1 degree 39' W., 283.97 ft. from the W. 1/4 corner of Section 25, and proceeding thence S. 1 degree 39' W., 163.35 ft., thence S. 88 degrees 21' e., 370 ft., thence N. 1 degree 39' E. along the W. line of Industrial Drive, 163.35 ft., thence N. 88 degrees 21' W., 370 ft. to the Point of Beginning, containing approximately 1.39 acres of land, more or less. The said land is zoned for I-1 (Light Industrial) and the City reserves the right to specify the type of industry which may be established, the location, type of buildings, sewer and utilities.

Condition of Sale: Property must be built upon and substantially completed within one (1) year.

Any offer to purchase shall set forth the intended use of said land and the proposed development and improvement of same.

Such offer to purchase will be received on or before 2:00 p.m., E.D.T. Monday, May 16, 1977 at the office of the City Clerk, 201 S. Main Street, Plymouth, Michigan 48170.

The City specifically reserves the right to reject any and all bids and offers to purchase the aforesaid land.



Paul V. Brumfield  
City Clerk

**SOLD**

**DIBBLE DID IT!**

**CAN YOU READ SIGN LANGUAGE?**

**DIBBLE REALTY**

**453-1020**

## PLYMOUTH-CANTON Showcase of Homes

**REAL ESTATE  
BROKERS-  
SALES PERSONNEL**

**CALL  
453-6900  
FOR DETAILS**



**OPEN-HOUSE SUNDAY MAY 8th 2 - 5 p.m.** 8892 Morrison, E. of Main St. N of Joy Rd. **IMMEDIATE OCCUPANCY!** Distinctive three bedroom brick ranch with den, dining room, family room with fireplace, 1 1/2 baths, breakfast bar in kitchen, utility room, and garage. Situated on 1/2 acre lot in Plymouth Twp. Close to shopping areas. \$57,500

J. L. HUDSON  
453-2210



**CAPE COD** - In Plymouth Twp. on Main St. Four bedrooms (2 large up with balcony and 2 down), parkay floor in dining room, fireplace with raised hearth in living room, full basement, 2 baths. Could make one bedroom down into a family room or den. \$52,500.



11685 Spicer - well located tri-level home in Plymouth Twp. with brick and aluminum trim. This 8 year old home features 3 bedrooms and full bath on the upper level, living room and kitchen on the ground level, and 12 x 24 family room with fireplace, full bath and utility room on the lower level. There is an oversized 24 x 26 garage in the fully fence rear yard. Offered at \$47,900.

WM. FEHLIG  
453-7800



3 bedroom ranch on quiet, tree lined street in Plymouth. Spacious living room with dining etc. Nicely furnished basement. **IMPECCABLY MAINTAINED!** Convenient city location. \$39,500.

DIBBLE REALTY  
453-1020

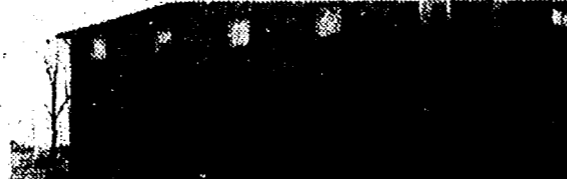

**OPEN SUNDAY MAY 15 2-5**  
No appointment necessary - - just stop in! This 2 bedroom condominium is ideal for retiree, young family or singles. Central air. **ALL APPLIANCES.** Carpeted throughout, curtains and drapes. 8% Land Contract easily assumed! Just \$22,500. 6812 New Providence Way. West of Sheldon, South of Warren. Canton Township

DIBBLE REALTY  
453-1020



**PLYMOUTH TOWNSHIP** - Charming older home on full acre! **HUGE** living room with magnificent fireplace. Spacious formal dining room. Country styled kitchen offers pleasant view of rear property. 2 bedroom, basement. Garage too. Real old fashioned workmanship and lovingly cared for. Retired owner asking \$40,900. Land contract terms.

DIBBLE REALTY  
453-1020



1386 S. Harvey - excellent starter home in the City. Featured are two bedrooms, large open living room, dining room combination, and full basement. 60 x 123 foot lot and fully fenced rear yard. Close to elementary school (Smith) and shopping area. Offered at \$23,900.

WM. FEHLIG  
453-7800



\$2.00 for 10 Words  
10¢ for each  
additional Word

# Crier Classifieds

CALL  
453-6900

PG 27  
THE COMMUNITY CRIER: May 11, 1977

DEADLINE 5 p.m. MONDAY

## ARTICLES FOR SALE

Table with six chairs, buffet, china cabinet, dehumidifier, deep freeze, clothes dryer, other items. 453-6192.

## ARTICLES FOR SALE

Entire furnishings of condominium. Lamps, sofas, chairs, tables, brand new stereo equipment. 455-4091.

## ARTICLES FOR SALE

For sale: 12 ft. Sunfish sail boat with trailer, 5 yrs. old. \$400. 453-3940 between 8 a.m. and 5 p.m.

Apt. Sale. Breaking up home. Furniture, dishes, silverware, kitchen items. Electric appliances, dining set and lamps, etc. 12-3 p.m. May 9, 10, 11. 41439 Wilcox Road, Lake Pointe Apts., Apt 49.

Bedroom set with twin beds, also double velvet headboard. Reasonable. 453-2488.

Garage and moving sale. Friday 9-5 p.m. Three family furniture antiques, household goods clothing (exec. cond.) Adams St. at Branch, Plymouth.

Artistic Interiors invites you to an art open house. Fine selection of original oil paintings from our "walking" art gallery. Sunday, May 15, 2-7 p.m. Everyone welcome. 42974 Lombardy Dr., Canton. 459-9498.

Stanley Home Products. Request a free catalog and information about home parties, individual orders and fund-raising plan for clubs. Verne Keeth, 455-2623.

## PETS

Schnauzer pups 5 weeks old, male and female. Mother also for sale. AKC after 5 p.m. 453-8003.

4 month gentle lovable male puppy part-collie, german shepherd de-wormed house broken, ginger colored. 453-3211.

Kittens. Free to good home. 2 males and 1 female. 459-0986 or 453-3313.

## ORCHESTRA

Dance music for your party. Experienced, versatile, and reasonable, four piece. 455-2605.

## LOST

Large Reward! For conn oboe (wood) taken from Central Middle School, name tag on, Jeff Bohr, 453-6583.

Lost, medium male part beagle and lab, white with brown spots. 453-7959. Reward.

## CURIOSITIES

Dave sharpens everything that's not illegal, immoral, or cuts grass at the Panhandler every Friday.

THANK YOU to the kind woman who informed us of our next door neighbors fire Monday morning.

TUCKER likes Ann Arbor Road House prime rib.

TIV BALOGH reads Crier Curiosities.

JIM JABARA chases kittens on Harvey St.

SCOTT & SUE: what a bash! How come Wendover's couldn't find it?

LOMAS has nine days left. She's hearing bells already!

SUZANNE DODGE - so you walked down from the 70th floor of the Ren Cen at 3 a.m. The real feat (sic), twinkletoes, is to walk UP 70 floors. ... Next time, S.

**GARLING**  
199 N. MAIN  
PLYMOUTH



OLDER 4-bedroom frame home in downtown Plymouth. Ideal for large family or good investment, zoned General Business. Land Contract Terms available. \$37,500.

NEW 3 bedroom tri-level going up in Plymouth Twp., 1½ baths, family room, carpet thru-out. Many extras. \$36,500.

453-4800

## NOTICE OF PUBLIC HEARING

Canton Township Compensation Commission will hold a Public Meeting at 7:30 p.m. on Thursday, May 12, 1977 at the township meeting hall, 128 Canton Center Rd. The Commission will make its determination of the compensation for elected officials of the township at that time.

## TOWNSHIP OF PLYMOUTH BOARD OF TRUSTEES - REGULAR MEETING APRIL 26, 1977

Clerk, Helen Richardson called the meeting to order at 8:00 p.m., followed by the Pledge of Allegiance. After which time Mr. Notebaert, Supervisor, arrived and assumed the chair. All members were present.

Mr. Millington moved approval of the minutes of the Regular Meeting of April 12, 1977, as submitted. Supported by Mr. Breen. All voting "approval" with the exception of Gornick and West who had been absent from the meeting.

Mr. West moved that the bills for the General Fund and Water and Sewer be approved in the amount of \$50,241.44. Supported by Mr. Millington and carried unanimously on a roll call vote.

Mrs. Richardson moved that the bids be closed on the purchase of a vehicle at 8:18 p.m. supported by Mr. Gornick and carried unanimously. Mr. Notebaert requested Mr. Briggs to read the bids, after opening by Clerk Richardson. Mr. Briggs suggested that the delivery date and the specifications be checked over, so consequently the awarding was tabled until Mr. Briggs checked in the bids. Mr. Notebaert tabled the bids until later in the evening.

Richard Gornick and Maurice Breen, Trustees, Re: Update on Peddler's Ordinance No. 23: Mr. Breen moved that the Township obtain a sample draft of an ordinance from either the M.T.A. or the Michigan Municipal League and then attempt to draft a Peddler's Ordinance for presentation to the Township within thirty days for the Board's perusal and future presentation to the Township Attorney. Supported by Mr. Gornick and carried unanimously.

Richard Gornick, Trustees and Committee. Re: Determination on Charter Townships versus General Law Twps. Mr. Notebaert asked that Mrs. Richardson read the three options concerning Township status as a Charter Township. Mrs. Richardson read the following: (1) Adopt, by majority vote, a resolution opposed to incorporation. (2) Adopt, by majority vote, a resolution of intent to approve incorporation. (+) Adopt, by majority vote, a resolution to place before electorate, the question of incorporation at the next regular or special Township election. After lengthy discussion Mr. Breen moved that the Township Board approve the Resolution of intent to approve incorporation. Supported by Mr. West. The following roll call was taken: Yes: M. Breen, J. West, R. Gornick, H. Richardson, T. Notebaert. No: L. Fidge, F. Millington. The motion carried 5-2. Mr. Gornick moved that the Chief Building Inspector and the Township Supervisor be authorized to investigate the variables of the low bids by re-evaluation mileage, service rendered, etc., and then approve the purchase of a vehicle. Supported by Mr. Millington and carried unanimously.

Plymouth Township Planning Commission. Re: Action taken at their meeting held on March 16, 1977 Planning Commission - Application No. 346. Re: Amendment to Ordinance No. 32 relative to sidewalks for lots 100' or more in R-1-S Zoning. Mr. Breen moved that we reject the recommendation of the Planning Commission as within a period of time, the residents will return with a petition for sidewalks to be constructed which should have been constructed at the time of development, sidewalks, should be required for safety reasons, as well as, for tricycles and children to get to and from school and that he did not like the language of the amend-

ment. Supported by Mrs. Fidge and carried 6-1 with Mr. Gornick voting "No."

Michael Berry - Application No. 363 - Re: Land Split - N. side of N. Territorial Road between Gottschalk and Napier Roads, 20 acre parcel into two (2) ten acre parcels. Mrs. Fidge moved approval of the recommended land split on the north side of N. Territorial between Gottschalk and Napier Road, Application No. 363. Supported by Mrs. Richardson and carried unanimously.

Thomas Notebaert, Supervisor. Re: Recommended appointments to the Zoning Board of Appeals. Mrs. Richardson was asked by Mr. Notebaert to read the letter to the Board, regarding the appointments to the Zoning Board of Appeals. The letter was to confirm the re-appointments of Frank Millington and Charles Childs to a two (2) year term which would expire on January 1, 1979 and to appoint John T. Kenney and Audrey B. Etienne to a three (3) year term which would expire on January 1, 1980 and Mr. John Goulet for a period of one (1) year, expiring January 1, 1978. Mr. Gornick moved approval of the recommended appointments to the Zoning Board of Appeals. Supported by Mr. West and carried unanimously.

Mr. Gornick moved that the request for the use of the ABS Truss Pipe for sanitary sewers in Westbriar Village Sub. No. 1 be approved. Supported by Mr. Millington and carried unanimously.

Mr. Gornick moved approval of the request of Mrs. Fidge to attend the symposium sessions in Ann Arbor on May 16-18 and approval of the \$60.00 Registration. Supported by Mrs. Richardson and carried unanimously.

Mr. West moved approval of the Clerk's request to purchase the Mosler Revo-File at a cost of \$1,777.50 Supported by Mr. Gornick and carried unanimously.

Mr. Breen moved to authorize the Township Engineers, Norman L. Dietrich and Associates to prepare the plans and specifications for bids on the sanitary sewer on Five Mile Road between Farmbrook and Maxwell. Supported by Mr. West and carried unanimously. Mrs. Richardson moved that the Township approve the expenditure of \$2,050.00 for the Land Use Study as proposed by Norman L. Dietrich and Associates and that said expenditures be taken from the Federal Revenue Sharing Funds, hopefully the Anti-Recession Funds. Supported by Mr. Breen and carried unanimously.

Mr. Breen moved that a moratorium be placed on rezonings until October 1, 1977 pending the land use and projected land uses from Norman L. Dietrich and Associates. Supported by Mr. Gornick and carried unanimously.

Mr. Breen moved to add to the agenda the Helping Hand Project. Supported by Mr. Millington and carried unanimously.

Mrs. Richardson moved that the Township wholeheartedly endorse the concept of the "Helping Hand Program" and that a suitable resolution be prepared and presented to the Plymouth Jaycee Auxiliary. Supported by Mrs. Fidge and carried unanimously.

Mr. Breen moved to adjourn the meeting. Supported by Mr. Gornick.

Supervisor Notebaert adjourned the meeting at 10:42 p.m.

Approved, Respectfully submitted  
Thomas G. Notebaert Helen I. Richardson  
Supervisor Clerk

THESE MINUTES ARE A SYNOPSIS. THE ORIGINAL MINUTES ARE ON FILE IN THE CLERK'S OFFICE.

**DAVE'S CARPET CLEANING**  
CARPET SALES AND SERVICE  
ALSO FURNITURE CLEANING  
459-3090

**ALL TYPE UPHOLSTERY**  
Sofas from \$169. Chairs from \$69. Kitchen and dining chairs from \$9.95  
**FURNITURE TOWN**  
533-6290  
18328 Six Mile  
5 DAY SERVICE

**CARPENTRY**  
Commercial/Residential  
**FORMICA**  
New Doors & Drawers  
Remodeling-Satisfactory Work  
Licensed Cabinets  
Pat Casey 478-0541

**MAC the Big Time Painter**  
MIKE MCCAULEY  
FREE ESTIMATES  
348-2164

**Plymouth Janitorial Service**  
Professional OFFICE CLEANING  
Hours at your convenience-References. Let our staff handle what you can't-don't have time to do.  
"Our business is to please YOUR customers"  
453-8297

**PAINTING**  
Interior and Exterior  
Ceiling and Wall Repairs  
FREE ESTIMATES  
Phone 326-2535. If no answer please call after 5 p.m. and any time weekends. No job too small. **INTRODUCING A NEW SERVICE TO DO-IT-YOURSELFERS At a Reasonable Price**  
1. Paint charts delivered to your home.  
2. Choose colors in privacy of home  
3. Paint will be delivered to your home.  
Phone Now and Save!

**FURNITURE REJUVENATION UNLTD.**  
NATURAL WOOD AND PAINTED FINISHES  
Single pieces to full bedroom and dining room sets  
For Information And Estimates Call: 459-4930  
DON'T REPLACE - REJUVENATE  
882 Holbrook

**CUSTOM CARPENTRY**  
BASEMENTS FINISHED  
CABINETS FORMICA TOP  
REMODELING WOOD BEAMS  
Dale Martin  
453-1760

**H.F. STEVENS**  
Asphalt Paving  
Residential Work, Repairs,  
Seal Coating  
453-2965  
Licensed and Insured

**SOD**  
Sycamore Farms Cutting Sod at 7278 Haggerty Rd. between Joy and Warren. Pick up or delivered 453-0723.

# Home Buyers Deserve Expert Help...



## ...they can count on Detroit & Northern

Because we specialize in home financing, you get the best help available when you talk to one of our home loan specialists. He'll tell you about our many loan plans and options and how to determine how costly a home you can afford. At D&N there is a loan plan right for every budget. Our home loan rates are competitive, but beyond that, the home buyer can expect much more at D&N.

### Several Options ...

We've been lending money to home buyers since 1889, and our experience shows in the service we render our customers. For example, at D&N we have several term options to help meet each borrower's particular needs. The term of the loan, along with the down payment amount and interest rate determine your monthly payment. Depending on the age and condition of the home, a term of up to 30 years may be selected. Ask a D&N home loan specialist to explain how your monthly payment is affected by the term you choose.

For your security, D&N offers mortgage life insurance. This protection provides for the full payment of your loan in the event of death. Disability insurance is available, too, providing for the payment of your monthly loan if the family breadwinner should become disabled.

### Loan Payment Convenience ...

In addition to security, D&N offers some real conveniences, too. To make your monthly payment as easy as possible, we have a plan called "Transmatic." With this plan, your mortgage payment is automatically deducted from your checking account and transferred to D&N on a set date each month. Using the "Transmatic" plan, you needn't worry about forgetting to make a payment when you are on vacation or out of town. A special trip and writing an additional check each month are eliminated when you choose "Transmatic."

### Handling Details ...

Many of the details involved in closing the deal will be handled by Detroit & Northern. We will arrange for an appraisal of the property, which will assist in determining the amount of the loan. If a survey is required, D&N will arrange for it. In addition, we can arrange for title insurance. D&N will perform the routine credit checks and handle the recording of your purchase. At the "closing," Detroit & Northern will assemble the various mortgage and legal documents and review them with you.

### Continuing Service ...

After receiving your Detroit & Northern home loan, you will enjoy the continuing services we provide homeowners. D&N will handle the payment of your property taxes, hazard insurance, mortgage life and disability insurance. For your records at the end of each year we will send you an analysis of your escrow account and a statement outlining each financial transaction.

**AT DETROIT & NORTHERN YOU ARE CONSIDERED A FRIEND AND NEIGHBOR. WE VALUE YOUR BUSINESS. BEFORE BUYING A HOME, SEE A DETROIT & NORTHERN HOME LOAN EXPERT. HE'S A PROFESSIONAL.**



37 OFFICES THROUGHOUT MICHIGAN

New CANTON OFFICE

6006 North Sheldon Road (at Ford)

459-9100

